

Schubkastensystem BLUM TANDEMBOX antaro

QuickFinder 2019



blum[®]

Schubkastensystem
TANDEMBOX antaro

Klappenbeschläge
AVENTOS

Scharniersysteme
CLIP top BLUMOTION



Seite 2

Schubkasten/Innenschubkasten TANDEMBOX antaro



Seite 4

Frontschubkasten TANDEMBOX antaro

Schubkastensystem BLUM TANDEMBOX antaro

– Führungen TANDEMBOX antaro	1
– Vorteile und Serviceleistungen auf den Punkt gebracht	B
– Komplett-Schubkasten montiert	
– Komplett-Schubkasten montiert mit Holzrückwand	2
– Komplett-Schubkasten-Sets Eigenfertigung	
– Komplett-Schubkasten-Sets für Holzrückwände	8
– Flexible-Schubkasten-Set's Eigenfertigung	
– Flexible-Schubkasten-Set's für Holz- oder Stahlrückwände	10
– Industrie Zargen Eigenfertigung	
– Industrie Zargen für Holz- oder Stahlrückwände	12
– Stahlrückwände	14
– Längsreling / Einschubelemente	16
– TANDEMBOX Frontbefestigungen / Zubehör Innenschubkästen	44



Einbau-Müllsysteme für TANDEMBOX antaro C oder D

– MÜLLEX - ZK-BOXX	19
– PEKA - Oeko	20
– FRANKE - Sorter 350	21



Schubkasten Innenorganisation

– Besteckeinsätze Basic - Kunststoff	3
– Schubkasteneinbauelemente	7
– Innenorganisation ORGA-LINE über Reling	17
– MOVE LINE	22
– ORGA-LINE Schalen-Sets	25
– ORGA-LINE Fach-Sets	27
– ORGA-LINE Kombi-Sets	29
– Anti-Rutschmatten / Küchenhelfer	32



MOVENTO – Führungen für Holzschubkasten

– MOVENTO S / BLUMOTION	33
– MOVENTO S / TIP-ON BLUMOTION	34
– MOVENTO / TIP-ON	35



Elektromechanische Öffnungsunterstützung

– SERVO-DRIVE	36
---------------	----



Auszug AVENTOS-Klappenbeschläge

– AVENTOS Hochschwenkbeschläge HF / HS / HL	38
– AVENTOS Klappenbeschläge HK top / HK-S / HK-XS	39



Auszug Scharnierprogramm

– CLIP TOP / CLIP TOP BLUMOTION	40
– Montageplatten / TIP-ON	43



Führungen TANDEMBOX antaro

Vollauszug 578/576



Lieferumfang:
• Korpuschiene links/rechts



Lieferumfang:
• Korpuschiene links/rechts



Korpuschiene BLUM TANDEMBOX antaro BLUMOTION

Nennlänge	MP = Multipack L/R - Packung 1/10 IP = Industriepack L/R - Packung 20			MP = Multipack L/R - Packung 1/8 IP = Industriepack L/R - Packung 16		
	30 kg MP	30 kg IP	Werks-Nr.	65 kg MP	65 kg IP	Werks-Nr.
270 mm	53.891.01	-	578.2701B	-	-	-
300 mm	53.891.02	-	578.3001B	-	-	-
350 mm	53.891.03	-	578.3501B	-	-	-
400 mm	53.891.04	-	578.4001B	-	-	-
450 mm	53.891.05	53.894.05	578.4501B	53.891.15	53.894.15	576.4501B
500 mm	53.891.08	53.894.06	578.5001B	53.891.16	53.894.16	576.5001B
550 mm	53.891.11	53.894.07	578.5501B	53.891.17	53.894.17	576.5501B
600 mm	53.891.14	-	578.6001B	53.891.18	-	576.6001B
650 mm	-	-	-	53.891.19	-	576.6501B

Korpuschiene BLUM TANDEMBOX antaro TIP-ON BLUMOTION

Nennlänge	Multipack L/R - Packung 1/10		Packung 1/8	
	30 kg	Werks-Nr.	65 kg	Werks-Nr.
270 mm	53.891.40	578.2701M	-	-
300 mm	53.891.41	578.3001M	-	-
350 mm	53.891.42	578.3501M	-	-
400 mm	53.891.43	578.4001M	-	-
450 mm	53.891.44	578.4501M	53.891.48	576.4501M
500 mm	53.891.45	578.5001M	53.891.49	576.5001M
550 mm	53.891.46	578.5501M	53.891.50	576.5501M
600 mm	53.891.47	578.6001M	53.891.51	576.6001M
650 mm	-	-	53.891.52	576.6501M

Seitenstabilisierung BLUM TANDEMBOX



Korpusbreite 900 - 1200 mm
Lieferumfang:
• 1 Stück

Nennlänge	OPO-Nr.	Werks-Nr.
450 mm	53.803.65	ZST.450BA
500 mm	53.803.66	ZST.500BA
550 mm	53.803.67	ZST.550BA
600 mm	53.803.68	ZST.600BA
650 mm	53.803.69	ZST.650BA

Zuschnitt: LW - 86 mm

Einheit-Mitnehmer TIP-ON BLUMOTION



Lieferumfang:
• Einheit und Mitnehmer
• **2 Stück Synchro-Adapter**

Typ	Nennlänge	OPO-Nr.	Werks-Nr.
S0/ 0 - 10 kg	270 - 300 mm	53.892.25	T60B3030
S1/10 - 20 kg	270 - 300 mm	53.892.26	T60B3130
L1/ 0 - 20 kg	350 - 600 mm	53.892.27	T60B3330
L3/ 5 - 40 kg	350 - 600 mm	53.892.28	T60B3530
L5/25 - 35 kg	450 - 650 mm*	53.892.29	T60B3560

* nur für 65 kg Vollauszug

Distanzleiste für Türeinsprung



Lieferumfang:
• 1 Stück
H/B/L: 25/50/486 mm

OPO-Nr.	Farbe
53.058.01	weiss
53.058.03	dunkelgrau
53.058.04	schwarz

Direkt-Befestigungsschrauben, Bohr-ø 5 mm

Antrieb: TX 20, ø 6.3 mm, Stahl vernickelt



Lieferumfang:
• 1 Packung (à 1000)

Länge	Packung 100	Packung 1000	Werks-Nr.
10.5 mm	48.556.01	48.556.11	661.1000.HG
11.5 mm	48.556.03	48.556.13	661.1150.HG
14.0 mm	48.556.02	48.556.12	661.1450.HG
36.0 mm	48.556.04	48.556.14	-
40.0 mm	48.556.05	48.556.15	-

Spanlattenschrauben OK-LINE

ohne Schaft, Antrieb: TX 15, ø 3.5 mm, Stahl verzinkt



Lieferumfang:
• 1 Packung (à 1'000)

Länge	Packung 1000	Werks-Nr.
16 mm	85.175.3516	-

Synchro-Welle TIP-ON BLUMOTION



Lieferumfang:
• 1 Stück

Korpusbreite	Lichte Weite (LW)	OPO-Nr.	Werks-Nr.
275 - 300 mm	238 - 286 mm	53.890.71*	T60.300D
300 - 1400 mm	287 - 1370 mm	51.170.06**	T60.1125W

Zuschnitt: * LW -214 mm, ** LW -240 mm

Synchro-Adapter TIP-ON BLUMOTION Ersatzteil

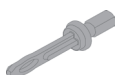

Lieferumfang:
• 1 Stück (2 Stück pro Schubkasten erforderlich)

Korpusbreite	OPO-Nr.	Werks-Nr.
275 - 1200 mm	51.170.05	T60.000D

Halterung Synchronisierungswelle TIP-ON BLUMOTION

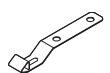

Lieferumfang:
• 1 Stück

Korpusbreite	OPO-Nr.	Werks-Nr.
> 750 mm	53.890.70	T60B000H

Zentrierbohrer, Bohr-ø 2,7 mm



Lieferumfang:
1 Stück

OPO-Nr.	Werks-Nr.
23.190.01	M01.ZZ03

mit gefederter Führungshülse

Komplett-Schubkasten montiert für Standard- oder individuelle Korpusbreiten

Systemhöhe 68 mm bis 83 mm



Lieferumfang Komplettschubkasten:

- 1 Stück Stahlschubkasten mit Holzboden und Holzrückwand
- 2 Stück Abdeckkappen mit BLUM Logo
- **ohne** Frontbefestigungen - bitte separat bestellen
- **ohne** Führungen - bitte separat bestellen

Herdschubkasten N, Farbe seidenweiss TANDEMBOX antaro

Standardbreiten für Korpusseitenstärke 16 mm

Nennlänge	Korpusbreite in mm													
	275	300	350	400	450	500	550	600	700	800	900	1000	1100	1200
400 mm	-	-	-	-	-	-	-	-	-	-	-	-	-	-
450 mm	-	-	-	-	-	-	53.240.06	53.240.07	-	-	53.240.10	-	-	-
500 mm	-	-	-	-	-	-	53.240.26	53.240.27	-	-	53.240.30	-	-	-
550 mm	-	-	-	-	-	-	-	-	-	-	-	-	-	-

Herdschubkasten N, Farbe seidenweiss, grau RAL 9006, terraschwarz TANDEMBOX antaro

Standard- oder individuelle Breiten für Korpusseitenstärke 16 oder 19 mm

Notwendige Bestellangabe: Schubkastenfarbe, Korpusbreite, Korpusseitenstärke, lichte Korpusbreite

Nennlänge*	Korpusbreite in mm													
	< 300	301-350	351-400	401-450	451-500	501-550	551-600	601-700	701-800	801-900	901-1000	1001-1100	1101-1200	
400 mm	-	-	-	-	-	-	-	-	-	-	-	-	-	-
450 mm	-	-	-	-	54.106.84	54.106.85	54.106.86	54.106.87	54.106.88	54.106.89	54.106.90	54.106.91	54.106.92	54.106.93
500 mm	-	-	-	-	54.107.04	54.107.05	54.107.06	54.107.07	54.107.08	54.107.09	54.107.10	54.107.11	54.107.12	54.107.13
550 mm	-	-	-	-	-	-	-	-	-	-	-	-	-	-

Lieferzeit ca. 15 Arbeitstage

* weitere Nennlängen und Breiten unter 54.107.99 bestellbar

Schubkasten/Innenschubkasten M, Farbe seidenweiss TANDEMBOX antaro

Standardbreiten für Korpusseitenstärke 16 mm

Nennlänge	Korpusbreite in mm													
	275	300	350	400	450	500	550	600	700	800	900	1000	1100	1200
400 mm	-	-	-	-	-	-	-	-	-	-	-	-	-	-
450 mm	-	-	-	-	-	-	-	-	-	-	-	-	-	-
500 mm	53.240.40	53.240.41	53.240.42	53.240.43	53.240.44	53.240.45	53.240.46	53.240.47	53.240.48	53.240.49	53.240.50	53.240.51	53.240.52	53.240.53
550 mm	53.240.60	53.240.61	53.240.62	53.240.63	53.240.64	53.240.65	53.240.66	53.240.67	53.240.68	53.240.69	53.240.70	53.240.71	53.240.72	53.240.73

Schubkasten/Innenschubkasten M, Farbe seidenweiss, grau RAL 9006, terraschwarz TANDEMBOX antaro

Standard- oder individuelle Breiten für Korpusseitenstärke 16 oder 19 mm

Notwendige Bestellangabe: Schubkastenfarbe, Korpusbreite, Korpusseitenstärke, lichte Korpusbreite

Nennlänge*	Korpusbreite in mm													
	< 300	301-350	351-400	401-450	451-500	501-550	551-600	601-700	701-800	801-900	901-1000	1001-1100	1101-1200	
400 mm	-	54.107.21	54.107.22	54.107.23	54.107.24	54.107.25	54.107.26	54.107.27	54.107.28	54.107.29	54.107.30	54.107.31	54.107.32	54.107.33
450 mm	-	54.107.41	54.107.42	54.107.43	54.107.44	54.107.45	54.107.46	54.107.47	54.107.48	54.107.49	54.107.50	54.107.51	54.107.52	54.107.53
500 mm	-	54.107.61	54.107.62	54.107.63	54.107.64	54.107.65	54.107.66	54.107.67	54.107.68	54.107.69	54.107.70	54.107.71	54.107.72	54.107.73
550 mm	-	54.107.81	54.107.82	54.107.83	54.107.84	54.107.85	54.107.86	54.107.87	54.107.88	54.107.89	54.107.90	54.107.91	54.107.92	54.107.93

Lieferzeit ca. 15 Arbeitstage

* weitere Nennlängen und Breiten unter 54.107.99 bestellbar

Komplett-Schubkasten montiert für Standard- oder individuelle Korpusbreiten Systemhöhe 115 mm



Lieferumfang Komplettschubkasten:

- 1 Stück Stahlschubkasten mit Holzboden und Holzrückwand
- 2 Stück Abdeckkappen mit BLUM Logo
- **ohne** Frontbefestigungen - bitte separat bestellen
- **ohne** Führungen - bitte separat bestellen

Schubkasten/Innenschubkasten K, Farbe seidenweiss, grau RAL 9006, terraschwarz TANDEMBOX antaro

Standard- oder individuelle Breiten für Korpusseitenstärke 16 oder 19 mm

Notwendige Bestellangabe: Schubkastenfarbe, Korpusbreite, Korpusseitenstärke, lichte Korpusbreite

Systemhöhe K 115 mm

Nennlänge*	Korpusbreite in mm													
	< 300	301-350	351-400	401-450	451-500	501-550	551-600	601-700	701-800	801-900	901-1000	1001-1100	1001-1200	
400 mm	-	54.109.61	54.109.62	54.109.63	54.109.64	54.109.65	54.109.66	54.109.67	54.109.68	54.109.69	54.109.70	54.109.71	54.109.72	54.109.73
450 mm	-	54.109.81	54.109.82	54.109.83	54.109.84	54.109.85	54.109.86	54.109.87	54.109.88	54.109.89	54.109.90	54.109.91	54.109.92	54.109.93
500 mm	-	54.110.01	54.110.02	54.110.03	54.110.04	54.110.05	54.110.06	54.110.07	54.110.08	54.110.09	54.110.10	54.110.11	54.110.12	54.110.13
550 mm	-	54.110.21	54.110.22	54.110.23	54.110.24	54.110.25	54.110.26	54.110.27	54.110.28	54.110.29	54.110.30	54.110.31	54.110.32	54.110.33

Lieferzeit ca. 15 Arbeitstage

* weitere Nennlängen und Breiten unter 54.107.99 bestellbar

Frontschubkasten / Frontinnenschubkasten mit Zargenhöhe K finden Sie auf Seite 6

Besteckeinsatz Basic M

Fixzuschnitt zum direkten Einlegen in TANDEMBOX Schubkästen mit Seitenstärke 16 mm, geradlinige Facheinteilung,



Gewürz- Messereinsätze Basic M

Zum Einlegen in Besteckeinsatz Basic ab Korpusbreite 600 mm



Kunststoff

Korpusbreite	Ausführung	seidenweiss	terraschwarz
600-1200 mm	Messerhalter	53.040.80	53.040.90
600-1200 mm	Dosenhalter	53.040.81	53.040.91

Korpusbreite	seidenweiss		terraschwarz	
	NL 500 mm	NL 550 mm	NL 500 mm	NL 550 mm
300 mm	-	-	-	-
400 mm	53.048.50	-	53.048.70	-
450 mm	53.048.51	-	53.048.71	-
500 mm	53.048.52	-	53.048.72	-
550 mm	53.048.53	53.048.59	53.048.73	53.048.79
600 mm	53.048.54	53.048.60	53.048.74	53.048.80
800 mm	53.048.55	53.048.61	53.048.75	53.048.81
900 mm	53.048.56	53.048.62	53.048.76	53.048.82
1000 mm	-	-	-	-
1100 mm	53.048.57	53.048.63	53.048.77	53.048.83
1200 mm	53.048.58	53.048.64	53.048.78	53.048.84

Komplett-Frontschubkasten montiert für Standard- oder individuelle Korpusbreiten

Systemhöhe 192 bis 224 mm



Lieferumfang Komplettschubkasten:

- 1 Stück Stahlschubkasten mit Holzboden und hoher Holzrückwand
- 2 Stück Abdeckkappen mit BLUM Logo
- **ohne** Frontbefestigungen - bitte separat bestellen
- **ohne** Führungen - bitte separat bestellen
- **ohne** Einschubelemente - bitte separat bestellen

Frontschubkasten/Frontinnenschubkasten M/C, Farbe seidenweiss TANDEMBOX antaro

Standardbreiten für Korpusseitenstärke 16 mm

Nennlänge	Korpusbreite in mm													
	275	300	350	400	450	500	550	600	700	800	900	1000	1100	1200
400 mm	-	-	-	-	-	-	-	-	-	-	-	-	-	-
450 mm	-	-	-	-	-	-	53.242.06	53.242.07	-	-	-	-	-	-
500 mm	53.242.10	53.242.11	53.242.12	53.242.13	53.242.14	53.242.15	53.242.16	53.242.17	53.242.18	53.242.19	53.242.20	53.242.21	53.242.22	53.242.23
550 mm	53.242.30	53.242.31	53.242.32	53.242.33	53.242.34	53.242.35	53.242.36	53.242.37	53.242.38	53.242.39	53.242.40	53.242.41	53.242.42	53.242.43

Frontschubkasten/Frontinnenschubkasten M/C, Farbe seidenweiss, grau RAL 9006, terraschwarz TANDEMBOX antaro

Standard- oder individuelle Breiten für Korpusseitenstärke 16 oder 19 mm

Notwendige Bestellangabe: Schubkastenfarbe, Korpusbreite, Korpusseitenstärke, lichte Korpusbreite

Nennlänge*	Korpusbreite in mm													
	< 300	301-350	351-400	401-450	451-500	501-550	551-600	601-700	701-800	801-900	901-1000	1001-1100	1101-1200	
400 mm	-	54.108.01	54.108.02	54.108.03	54.108.04	54.108.05	54.108.06	54.108.07	54.108.08	54.108.09	54.108.10	54.108.11	54.108.12	54.108.13
450 mm	-	54.108.21	54.108.22	54.108.23	54.108.24	54.108.25	54.108.26	54.108.27	54.108.28	54.108.29	54.108.30	54.108.31	54.108.32	54.108.33
500 mm	-	54.108.41	54.108.42	54.108.43	54.108.44	54.108.45	54.108.46	54.108.47	54.108.48	54.108.49	54.108.50	54.108.51	54.108.52	54.108.53
550 mm	-	54.108.61	54.108.62	54.108.63	54.108.64	54.108.65	54.108.66	54.108.67	54.108.68	54.108.69	54.108.70	54.108.71	54.108.72	54.108.73

Lieferzeit ca. 15 Arbeitstage

* weitere Nennlängen und Breiten unter 54.107.99 bestellbar

Frontschubkasten/Frontinnenschubkasten M/D, Farbe seidenweiss TANDEMBOX antaro

Standardbreiten für Korpusseitenstärke 16 mm

Nennlänge	Korpusbreite in mm													
	275	300	350	400	450	500	550	600	700	800	900	100	1100	1200
400 mm	-	-	-	-	-	-	-	-	-	-	-	-	-	-
450 mm	-	-	-	-	-	-	53.242.56	53.242.57	-	-	-	-	-	-
500 mm	-	-	-	-	-	-	-	-	-	-	-	-	-	-
550 mm	-	-	-	-	-	-	-	-	-	-	-	-	-	-

Frontschubkasten/Frontinnenschubkasten M/D, Farbe seidenweiss, grau RAL 9006, terraschwarz TANDEMBOX antaro

Standard- oder individuelle Breiten für Korpusseitenstärke 16 oder 19 mm

Notwendige Bestellangabe: Schubkastenfarbe, Korpusbreite, Korpusseitenstärke, lichte Korpusbreite

Nennlänge*	Korpusbreite in mm													
	< 300	301-350	351-400	401-450	451-500	501-550	551-600	601-700	701-800	801-900	901-1000	1001-1100	1101-1200	
400 mm	-	54.108.81	54.108.82	54.108.83	54.108.84	54.108.85	54.108.86	54.108.87	54.108.88	54.108.89	54.108.90	54.108.91	54.108.92	54.108.93
450 mm	-	54.109.01	54.109.02	54.109.03	54.109.04	54.109.05	54.109.06	54.109.07	54.109.08	54.109.09	54.109.10	54.109.11	54.109.12	54.109.13
500 mm	-	54.109.21	54.109.22	54.109.23	54.109.24	54.109.25	54.109.26	54.109.27	54.109.28	54.109.29	54.109.30	54.109.31	54.109.32	54.109.33
550 mm	-	54.109.41	54.109.42	54.109.43	54.109.44	54.109.45	54.109.46	54.109.47	54.109.48	54.109.49	54.109.50	54.109.51	54.109.52	54.109.53

Lieferzeit ca. 15 Arbeitstage

* weitere Nennlängen und Breiten unter 54.107.99 bestellbar

Systemhöhe C 192 mm

Systemhöhe D 224 mm

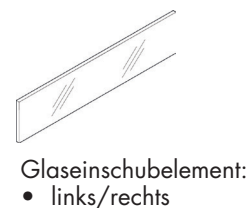
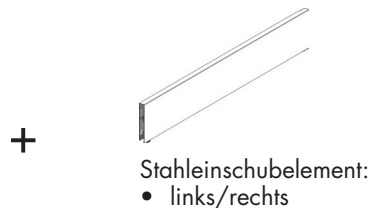
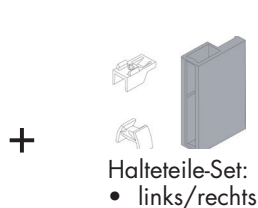
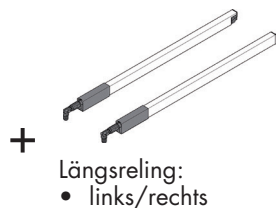

Längsreling seidenweiss	Halteteile-Set C seidenweiss	Stahleinschubelement seidenweiss	grau RAL 9006	terraschwarz	Glaseinschubelement satinier	klar
-	-	-	-	-	-	-
53.802.05	53.802.39	53.802.40	-	-	53.802.55	53.802.65
53.802.06	53.802.39	53.802.41	-	-	53.802.56	53.802.66
53.802.07	53.802.39	53.802.42	-	-	53.802.57	53.802.67

Längsreling seidenweiss	grau RAL 9006	terraschwarz	Halteteile-Set C seidenweiss	grau RAL 9006	terraschwarz	Stahleinschubelement seidenweiss	grau RAL 9006	terraschwarz	Glaseinschubelement satinier	klar
53.802.04	53.812.04	53.822.04	53.802.39	53.832.39	-	-	-	-	53.802.54	53.802.64
53.802.05	53.812.05	53.822.05	53.802.39	53.832.39	-	53.802.40	53.812.40	53.822.40	53.802.55	53.802.65
53.802.06	53.812.06	53.822.06	53.802.39	53.832.39	-	53.802.41	53.812.41	53.822.41	53.802.56	53.802.66
53.802.07	53.812.07	53.822.07	53.802.39	53.832.39	-	53.802.42	53.812.42	53.822.42	53.802.57	53.802.67

Längsreling seidenweiss	Halteteile-Set D seidenweiss	Stahleinschubelement seidenweiss	Glaseinschubelement satinier	klar
-	-	-	-	-
53.802.05	53.803.05	53.803.10	53.803.25	53.803.35
-	-	-	-	-
-	-	-	-	-

Längsreling seidenweiss	grau RAL 9006	terraschwarz	Halteteile-Set D seidenweiss	grau RAL 9006	terraschwarz	Stahleinschubelement seidenweiss	grau RAL 9006	terraschwarz	Glaseinschubelement satinier	klar
53.802.04	53.812.04	53.822.04	53.803.05	53.813.05	53.823.05	-	-	-	53.803.24	53.803.34
53.802.05	53.812.05	53.822.05	53.803.05	53.813.05	53.823.05	53.803.10	53.813.10	53.822.10	53.803.25	53.803.35
53.802.06	53.812.06	53.822.06	53.803.05	53.813.05	53.823.05	53.803.11	53.813.11	53.822.11	53.803.26	53.803.36
53.802.07	53.812.07	53.822.07	53.803.05	53.813.05	53.823.05	53.803.12	53.813.12	53.822.12	53.803.26	53.803.37

Komplett-Schubkasten montiert für Standard- oder individuelle Korpusbreiten

Systemhöhe 115 mm bis 224 mm



Lieferumfang Komplettschubkasten:

- 1 Stück Stahlschubkasten mit Holzboden und Holzrückwand
- 2 Stück Abdeckkappen mit BLUM Logo
- **ohne** Frontbefestigungen - bitte separat bestellen
- **ohne** Führungen - bitte separat bestellen

Schubkasten/Innenschubkasten K, Farbe seidenweiss, grau RAL 9006, terraschwarz TANDEMBOX antaro

Standard- oder individuelle Breiten für Korpusseitenstärke 16 oder 19 mm

Notwendige Bestellangabe: Schubkastenfarbe, Korpusbreite, Korpusseitenstärke, lichte Korpusbreite

Systemhöhe K 115 mm

Nennlänge*	Korpusbreite in mm													
	< 300	301-350	351-400	401-450	451-500	501-550	551-600	601-700	701-800	801-900	901-1000	1001-1100	1001-1200	
400 mm	-	54.109.61	54.109.62	54.109.63	54.109.64	54.109.65	54.109.66	54.109.67	54.109.68	54.109.69	54.109.70	54.109.71	54.109.72	54.109.73
450 mm	-	54.109.81	54.109.82	54.109.83	54.109.84	54.109.85	54.109.86	54.109.87	54.109.88	54.109.89	54.109.90	54.109.91	54.109.92	54.109.93
500 mm	-	54.110.01	54.110.02	54.110.03	54.110.04	54.110.05	54.110.06	54.110.07	54.110.08	54.110.09	54.110.10	54.110.11	54.110.12	54.110.13
550 mm	-	54.110.21	54.110.22	54.110.23	54.110.24	54.110.25	54.110.26	54.110.27	54.110.28	54.110.29	54.110.30	54.110.31	54.110.32	54.110.33

Lieferzeit ca. 15 Arbeitstage

* weitere Nennlängen und Breiten unter 54.107.99 bestellbar



Lieferumfang Komplettschubkasten:

- 1 Stück Stahlschubkasten mit Holzboden und hoher Holzrückwand
- 2 Stück Abdeckkappen mit BLUM Logo
- **ohne** Frontbefestigungen - bitte separat bestellen
- **ohne** Führungen - bitte separat bestellen
- **ohne** Einschubelemente - bitte separat bestellen

Frontschubkasten/Frontinnenschubkasten K/D, Farbe seidenweiss, grau RAL 9006, terraschwarz TANDEMBOX antaro

Standard- oder individuelle Breiten für Korpusseitendicke 16 oder 19 mm

Notwendige Bestellangabe: Schubkastenfarbe, Korpusbreite, Korpusseitenstärke, lichte Korpusbreite

Systemhöhe D 224 mm

Nennlänge*	Korpusbreite in mm													
	< 300	301-350	351-400	401-450	451-500	501-550	551-600	601-700	701-800	801-900	901-1000	1001-1100	1101-1200	
400 mm	-	-	-	-	-	-	-	-	-	-	-	-	-	
450 mm	-	54.111.21	54.111.22	54.111.23	54.111.24	54.111.25	54.111.26	54.111.27	54.111.28	54.111.29	54.111.30	54.111.31	54.111.32	54.111.33
500 mm	-	54.111.41	54.111.42	54.111.43	54.111.44	54.111.45	54.111.46	54.111.47	54.111.48	54.111.49	54.111.50	54.111.51	54.111.52	54.111.53
550 mm	-	54.111.61	54.111.62	54.111.63	54.111.64	54.111.65	54.111.66	54.111.67	54.111.68	54.111.69	54.111.70	54.111.71	54.111.72	54.111.73

Lieferzeit ca. 15 Arbeitstage

* weitere Nennlängen und Breiten unter 54.107.99 bestellbar

Universal BROTBBOX Schubladen-Einsatz, C/D, NL 500 mm

Broteinsatz aus CDF, glatt, Farbe anthrazit, Boden fest montiert, einfach zum Reinigen

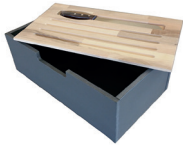

Korpusbreite	Ahorn	Nussbaum
350-1200 mm	53.082.01	53.082.02

Brot Schubladen-Einsatz, C/D, NL 500 mm

Broteinsatz aus Massivholz, mit demontablem Krümelboden,



Korpusbreite	Buche	Ahorn
550/600 mm	53.082.10	53.082.11
auf Mass	53.082.20	53.082.21

Einbau-Allesschneider RITTER AES 72, M/K, NL 500 mm

Stahl, silber Vollmetallausführung

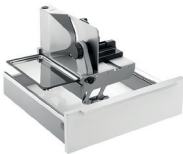

Korpusbreite	Arbeitsplatte	rechts
450 - 1200 mm	Standard	53.340.60
500 - 1200 mm	Überdick	53.340.61

Einbau-Allesschneider RITTER AES, M/K, NL 500 mm

Stahl, silber Metallausführung

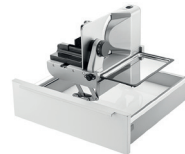

Korpusbreite	Arbeitsplatte	links	rechts
300 - 1200 mm	Standard	-	53.340.50
450 - 1200 mm	Standard	53.340.52	53.340.51
500 - 1200 mm	Überdick	53.340.54	53.340.53

Akku-Stabmixer RITTER ESM 50, M/K, NL 500 mm

kabelloser, akkubetriebener Stabmixer, Ladestation fest im Schubkasten montiert, Lichte Breite Schubkasten > 145 mm



Korpusbreite	silber
300 - 1200 mm	53.540.60

Einbau Toaster RITTER ET, M/K, NL 500 mm

Stahl, silber Metallausführung



Korpusbreite	Edelstahl
300 - 1200 mm	53.340.40

Allesschneider RITTER E 118-400

Stahl, silber Metallausführung



Korpusbreite	rechts
400 - 1200 mm	53.340.70

Versenksbeschläge

Stahl, weiss, Belastbarkeit 10 kg



Korpusbreite	rechts
500 - 1200 mm	53.491.03

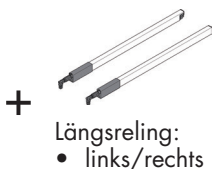

Längsreling		
seidenweiss	grau RAL 9006	terraschwarz

53.802.05	53.812.05	53.822.05
53.802.06	53.812.06	53.822.06
53.802.07	53.812.07	53.822.07

Komplett-Schubkasten-Sets Eigenfertigung für Holzurückwände

Systemhöhe 68 mm bis 224 mm

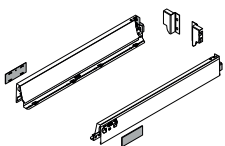

Schubkasten/Innenschubkasten

Lieferumfang TANDEMBOX antaro:

- 1 Stück Zarge links/rechts mit Abdeckkappen
- 1 Stück Holzrückwandhalter links/rechts
- für individuelle Breiten

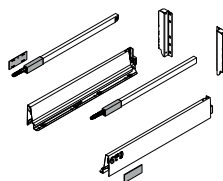

Frontschubkasten/Frontinnenschubkasten

Lieferumfang TANDEMBOX antaro:

- 1 Stück Zarge links/rechts mit Abdeckkappen
- 1 Stück Holzrückwandhalter links/rechts
- 1 Stück Reling links/rechts
- für individuelle Breiten

Zargenhöhe N

Systemhöhe N 68 mm

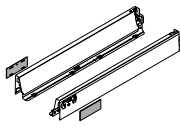

Herdschubkasten-Set N TANDEMBOX antaro

Nennlänge	seidenweiss	grau RAL 9006	terraschwarz	Werks-Nr.	Werks-Nr.
270 mm	-	-	-	-	-
300 mm	-	-	-	-	-
350 mm	-	-	-	-	-
400 mm	53.806.04	53.816.04	53.826.04	378N4002SA	+ Z30N000S.04
450 mm	53.806.05	53.816.05	53.826.05	378N4502SA	+ Z30N000S.04
500 mm	53.806.06	53.816.06	53.826.06	378N5002SA	+ Z30N000S.04
550 mm	53.806.07	53.816.07	53.826.07	378N5502SA	+ Z30N000S.04
600 mm	-	-	-	-	-
650 mm	-	-	-	-	-

Zargenhöhe M

Systemhöhe M 83 mm

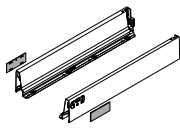

Schubkasten/Innenschubkasten-Set M TANDEMBOX antaro

Nennlänge	seidenweiss	grau RAL 9006	terraschwarz	Werks-Nr.	Werks-Nr.
270 mm	53.806.11	53.816.11	53.826.11	378M2702SA	+ Z30M000S.04
300 mm	53.806.12	53.816.12	53.826.12	378M3002SA	+ Z30M000S.04
350 mm	53.806.13	53.816.13	53.826.13	378M3502SA	+ Z30M000S.04
400 mm	53.806.14	53.816.14	53.826.14	378M4002SA	+ Z30M000S.04
450 mm	53.806.15	53.816.15	53.826.15	378M4502SA	+ Z30M000S.04
500 mm	53.806.16	53.816.16	53.826.16	378M5002SA	+ Z30M000S.04
550 mm	53.806.17	53.816.17	53.826.17	378M5502SA	+ Z30M000S.04
600 mm	53.806.18	53.816.18	53.826.18	378M6002SA	+ Z30M000S.04
650 mm	53.806.19	53.816.19	53.826.19	378M6502SA	+ Z30M000S.04

Zargenhöhe K

Systemhöhe K 115 mm

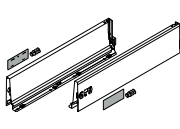

Schubkasten/Innenschubkasten -Set K TANDEMBOX antaro

Nennlänge	seidenweiss	grau RAL 9006	terraschwarz	Werks-Nr.	Werks-Nr.
270 mm	53.806.21	53.816.21	53.826.21	378K2702SA	+ Z30K000S.04
300 mm	53.806.22	53.816.22	53.826.22	378K3002SA	+ Z30K000S.04
350 mm	53.806.23	53.816.23	53.826.23	378K3502SA	+ Z30K000S.04
400 mm	53.806.24	53.816.24	53.826.24	378K4002SA	+ Z30K000S.04
450 mm	53.806.25	53.816.25	53.826.25	378K4502SA	+ Z30K000S.04
500 mm	53.806.26	53.816.26	53.826.26	378K5002SA	+ Z30K000S.04
550 mm	53.806.27	53.816.27	53.826.27	378K5502SA	+ Z30K000S.04
600 mm	53.806.28	53.816.28	53.826.28	378K6002SA	+ Z30K000S.04
650 mm	53.806.29	53.816.29	53.826.29	378K6502SA	+ Z30K000S.04

Komplett-Schubkasten-Sets Eigenfertigung für Holzrückwände

Systemhöhe 68 mm bis 224 mm

Zargenhöhe M in Kombination mit Längsreling

Systemhöhe B 159 mm

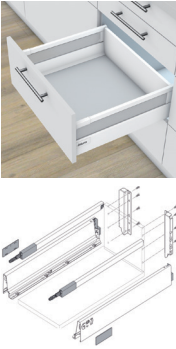

Frontschubkasten-Set M mit Reling B TANDEMBOX antaro

Nennlänge	seidenweiss	grau RAL 9006	terraschwarz	Werks-Nr.	Werks-Nr.	Werks-Nr.
270 mm	53.806.31	53.816.31	53.826.31	378M2702SA	+ Z30B000S.04	+ ZRG.207RSIC
300 mm	53.806.32	53.816.32	53.826.32	378M3002SA	+ Z30B000S.04	+ ZRG.237RSIC
350 mm	53.806.33	53.816.33	53.826.33	378M3502SA	+ Z30B000S.04	+ ZRG.287RSIC
400 mm	53.806.34	53.816.34	53.826.34	378M4002SA	+ Z30B000S.04	+ ZRG.337RSIC
450 mm	53.806.35	53.816.35	53.826.35	378M4502SA	+ Z30B000S.04	+ ZRG.387RSIC
500 mm	53.806.36	53.816.36	53.826.36	378M5002SA	+ Z30B000S.04	+ ZRG.437RSIC
550 mm	53.806.37	53.816.37	53.826.37	378M5502SA	+ Z30B000S.04	+ ZRG.487RSIC
600 mm	53.806.38	53.816.38	53.826.38	378M6002SA	+ Z30B000S.04	+ ZRG.537RSIC
650 mm	53.806.39	53.816.39	53.826.39	378M6502SA	+ Z30B000S.04	+ ZRG.587RSIC

Systemhöhe C 192 mm

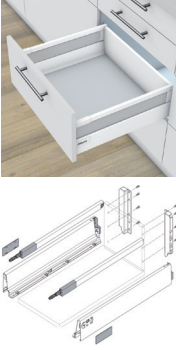

Frontschubkasten/Frontinnenschubkasten-Set M mit Reling C TANDEMBOX antaro

Nennlänge	seidenweiss	grau RAL 9006	terraschwarz	Werks-Nr.	Werks-Nr.	Werks-Nr.
270 mm	53.806.41	53.816.41	53.826.41	378M2702SA	+ Z30C000S.04	+ ZRG.207RSIC
300 mm	53.806.42	53.816.42	53.826.42	378M3002SA	+ Z30C000S.04	+ ZRG.237RSIC
350 mm	53.806.43	53.816.43	53.826.43	378M3502SA	+ Z30C000S.04	+ ZRG.287RSIC
400 mm	53.806.44	53.816.44	53.826.44	378M4002SA	+ Z30C000S.04	+ ZRG.337RSIC
450 mm	53.806.45	53.816.45	53.826.45	378M4502SA	+ Z30C000S.04	+ ZRG.387RSIC
500 mm	53.806.46	53.816.46	53.826.46	378M5002SA	+ Z30C000S.04	+ ZRG.437RSIC
550 mm	53.806.47	53.816.47	53.826.47	378M5502SA	+ Z30C000S.04	+ ZRG.487RSIC
600 mm	53.806.48	53.816.48	53.826.48	378M6002SA	+ Z30C000S.04	+ ZRG.537RSIC
650 mm	53.806.49	53.816.49	53.826.49	378M6502SA	+ Z30C000S.04	+ ZRG.587RSIC

Einbau-Müllsysteme siehe Seite 19 / Einschubelemente siehe Seite 16

Systemhöhe D 224 mm

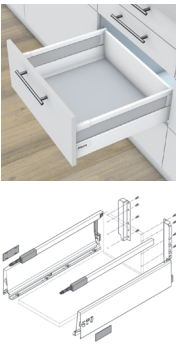

Frontschubkasten/Frontinnenschubkasten-Set M mit Reling D TANDEMBOX antaro

Nennlänge	seidenweiss	grau RAL 9006	terraschwarz	Werks-Nr.	Werks-Nr.	Werks-Nr.
270 mm	53.806.51	53.816.51	53.826.51	378M2702SA	+ Z30D000S.04	+ ZRG.207RSIC
300 mm	53.806.52	53.816.52	53.826.52	378M3002SA	+ Z30D000S.04	+ ZRG.237RSIC
350 mm	53.806.53	53.816.53	53.826.53	378M3502SA	+ Z30D000S.04	+ ZRG.287RSIC
400 mm	53.806.54	53.816.54	53.826.54	378M4002SA	+ Z30D000S.04	+ ZRG.337RSIC
450 mm	53.806.55	53.816.55	53.826.55	378M4502SA	+ Z30D000S.04	+ ZRG.387RSIC
500 mm	53.806.56	53.816.56	53.826.56	378M5002SA	+ Z30D000S.04	+ ZRG.437RSIC
550 mm	53.806.57	53.816.57	53.826.57	378M5502SA	+ Z30D000S.04	+ ZRG.487RSIC
600 mm	53.806.58	53.816.58	53.826.58	378M6002SA	+ Z30D000S.04	+ ZRG.537RSIC
650 mm	53.806.59	53.816.59	53.826.59	378M6502SA	+ Z30D000S.04	+ ZRG.587RSIC

Einbau-Müllsysteme siehe Seite 19 / Einschubelemente siehe Seite 16

Zargenhöhe K in Kombination mit Längsreling

Systemhöhe D 224 mm

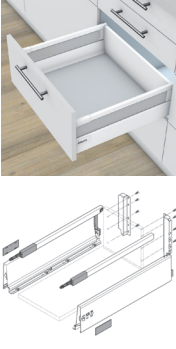

Frontschubkasten/Frontinnenschubkasten-Set K mit Reling D TANDEMBOX antaro

Nennlänge	seidenweiss	grau RAL 9006	terraschwarz	Werks-Nr.	Werks-Nr.	Werks-Nr.
270 mm	53.806.61	53.816.61	53.826.61	378K2702SA	+ Z30D000S.04	+ ZRG.207RSIC
300 mm	53.806.62	53.816.62	53.826.62	378K3002SA	+ Z30D000S.04	+ ZRG.237RSIC
350 mm	53.806.63	53.816.63	53.826.63	378K3502SA	+ Z30D000S.04	+ ZRG.287RSIC
400 mm	53.806.64	53.816.64	53.826.64	378K4002SA	+ Z30D000S.04	+ ZRG.337RSIC
450 mm	53.806.65	53.816.65	53.826.65	378K4502SA	+ Z30D000S.04	+ ZRG.387RSIC
500 mm	53.806.66	53.816.66	53.826.66	378K5002SA	+ Z30D000S.04	+ ZRG.437RSIC
550 mm	53.806.67	53.816.67	53.826.67	378K5502SA	+ Z30D000S.04	+ ZRG.487RSIC
600 mm	53.806.68	53.816.68	53.826.68	378K6002SA	+ Z30D000S.04	+ ZRG.537RSIC
650 mm	53.806.69	53.816.69	53.826.69	378K6502SA	+ Z30D000S.04	+ ZRG.587RSIC

Einbau-Müllsysteme siehe Seite 19 / Einschubelemente siehe Seite 16

Frontstabilisierung BLUM TANDEMBOX antaro

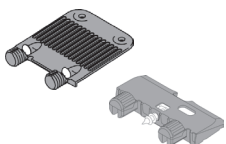

Lieferumfang:

- 1 Stück (empfohlen ab Korpusbreite 900 mm)

Montage	EXPANDO	Werks-Nr.	Montage	EXPANDO T	Werks-Nr.
	53.832.50	Z96.10E1		53.832.51	Z96.00T1
	53.890.72	Z96.2011		-	-

Flexible-Schubkasten-Sets Eigenfertigung für Holz- oder Stahlrückwände

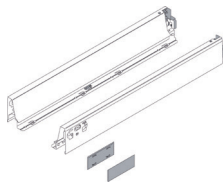

- Lieferumfang TANDEMBOX antaro:
- 1 Stück Zarge links/rechts mit Abdeckkappen
 - für individuelle Breiten

Zargenhöhe N



Herschubkasten-Set N TANDEMBOX antaro

Nennlänge	seidenweiss	grau RAL 9006	terraschwarz	Werks-Nr.
270 mm	-	-	-	-
300 mm	-	-	-	-
350 mm	-	-	-	-
400 mm	53.800.04	53.810.04	53.820.04	378N4002SA
450 mm	53.800.05	53.810.05	53.820.05	378N4502SA
500 mm	53.800.06	53.810.06	53.820.06	378N5002SA
550 mm	53.800.07	53.810.07	53.820.07	378N5502SA
600 mm	-	-	-	-
650 mm	-	-	-	-

Zargenhöhe M



Schubkasten/Innenschubkasten-Set M TANDEMBOX antaro

Nennlänge	seidenweiss	grau RAL 9006	terraschwarz	Werks-Nr.
270 mm	53.800.31	53.810.31	53.820.31	378M2702SA
300 mm	53.800.32	53.810.32	53.820.32	378M3002SA
350 mm	53.800.33	53.810.33	53.820.33	378M3502SA
400 mm	53.800.34	53.810.34	53.820.34	378M4002SA
450 mm	53.800.35	53.810.35	53.820.35	378M4502SA
500 mm	53.800.36	53.810.36	53.820.36	378M5002SA
550 mm	53.800.37	53.810.37	53.820.37	378M5502SA
600 mm	53.800.38	53.810.38	53.820.38	378M6002SA
650 mm	53.800.39	53.810.39	53.820.39	378M6502SA

Zargenhöhe K



Schubkasten/Innenschubkasten-Set K TANDEMBOX antaro

Nennlänge	seidenweiss	grau RAL 9006	terraschwarz	Werks-Nr.
270 mm	53.801.81	53.811.81	53.821.81	378K2702SA
300 mm	53.801.82	53.811.82	53.821.82	378K3002SA
350 mm	53.801.83	53.811.83	53.821.83	378K3502SA
400 mm	53.801.84	53.811.84	53.821.84	378K4002SA
450 mm	53.801.85	53.811.85	53.821.85	378K4502SA
500 mm	53.801.86	53.811.86	53.821.86	378K5002SA
550 mm	53.801.87	53.811.87	53.821.87	378K5502SA
600 mm	53.801.88	53.811.88	53.821.88	378K6002SA
650 mm	53.801.89	53.811.89	53.821.89	378K6502SA



Zuschnitt – 16 mm Spanplatten

	Rückwandhöhe (mm)	69	84	116	167	199
	Systemhöhe (mm)	N	M	K	C	D
	Schubkastenboden					
	Holzrückwand	NL – 24 mm				
	Stahlrückwand	NL – 22 mm				

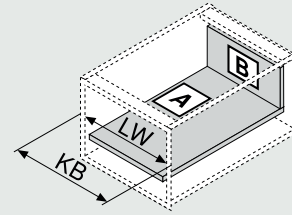

KB Korpusbreite
LW Lichte Korpusweite
NL Nennlänge

Holzrückwandhalter TANDEMBOX antaro

Lieferumfang:

- 1 Stück links/rechts
- für individuelle Breiten

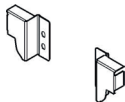

Schubkasten/Innenschubkasten

Zargenhöhe	Systemhöhe	seidenweiss	grau RAL 9006	terraschwarz	Werks-Nr.
N	N	53.800.09	53.810.09	53.820.09	Z30N000S.04
M	M	53.800.61	53.810.61	53.820.61	Z30M000S.04
K	K	53.801.90	53.811.90	53.821.90	Z30K000S.04

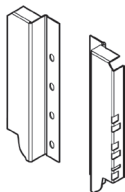
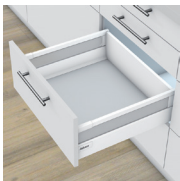

Frontschubkasten/Frontinnenschubkasten mit Reling

Zargenhöhe	Systemhöhe	seidenweiss	grau RAL 9006	terraschwarz	Werks-Nr.
M	B	53.804.40	53.814.40	53.824.40	Z30B000S.04
M/K	C	53.802.36	53.812.36	53.822.36	Z30C000S.04
M/K	D	53.803.01	53.813.01	53.823.01	Z30D000S.04

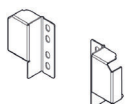

TANDEMBOX Relinghalter für Doppelreling (optional)

Zargenhöhe	Systemhöhe	seidenweiss	grau RAL 9006	terraschwarz	Werks-Nr.
M/K	unabhängig	53.802.31	53.812.31	53.822.31	ZRR.5200

Längsreling für Frontauszug BLUM TANDEMBOX antaro

Lieferumfang:

- Längsreling rechts/links (Einzelpaar)



Nennlänge	Zargenhöhe	Systemhöhe	seidenweiss	grau RAL 9006	terraschwarz	Werks-Nr.
270 mm	M/K	B/C/D	53.802.01	53.812.01	53.822.01	ZRG.207RSIC
300 mm	M/K	B/C/D	53.802.02	53.812.02	53.822.02	ZRG.237RSIC
350 mm	M/K	B/C/D	53.802.03	53.812.03	53.822.03	ZRG.287RSIC
400 mm	M/K	B/C/D	53.802.04	53.812.04	53.822.04	ZRG.337RSIC
450 mm	M/K	B/C/D	53.802.05	53.812.05	53.822.05	ZRG.387RSIC
500 mm	M/K	B/C/D	53.802.06	53.812.06	53.822.06	ZRG.437RSIC
550 mm	M/K	B/C/D	53.802.07	53.812.07	53.822.07	ZRG.487RSIC
600 mm	M/K	B/C/D	53.802.08	53.812.08	53.822.08	ZRG.537RSIC
650 mm	M/K	B/C/D	53.802.09	53.812.09	53.822.09	ZRG.587RSIC

Einschubelemente siehe Seite 16

Industrie Zargen Eigenfertigung für Holz- oder Stahlrückwände

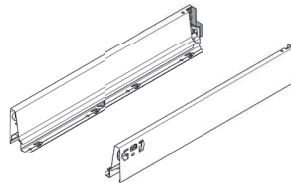

- Lieferumfang TANDEMBOX antaro Zargen Industrie:
- Packung: 20 Stück Zargen links/rechts (IP)
 - **ohne** Abdeckkappen
 - für individuelle Breiten

Zargenhöhe M



Schubkasten-Zargen M TANDEMBOX antaro (links/rechts)

Nennlänge	seidenweiss	grau RAL 9006	terraschwarz	links	rechts
				Werks-Nr.	Werks-Nr.
270 mm	-	-	-	378M2702SA LI	+ 378M2702SA RE
300 mm	-	-	-	378M3002SA LI	+ 378M3002SA RE
350 mm	53.804.83	-	-	378M3502SA LI	+ 378M3502SA RE
400 mm	53.804.84	-	-	378M4002SA LI	+ 378M4002SA RE
450 mm	53.804.85	53.814.85	-	378M4502SA LI	+ 378M4502SA RE
500 mm	53.804.86	53.814.66	-	378M5002SA LI	+ 378M5002SA RE
550 mm	53.804.87	53.814.87	-	378M5502SA LI	+ 378M5502SA RE
600 mm	53.804.88	-	-	378M6002SA LI	+ 378M6002SA RE
650 mm	53.804.89	-	-	378M6502SA LI	+ 378M6502SA RE

Zargenhöhe K



Schubkasten-Zargen K TANDEMBOX antaro (links/rechts)

Nennlänge	seidenweiss	grau RAL 9006	terraschwarz	links	rechts
				Werks-Nr.	Werks-Nr.
270 mm	-	-	-	378K2702SA LI	+ 378K2702SA RE
300 mm	-	-	-	378K3002SA LI	+ 378K3002SA RE
350 mm	-	-	-	378K3502SA LI	+ 378K3502SA RE
400 mm	-	-	-	378K4002SA LI	+ 378K4002SA RE
450 mm	-	-	-	378K4502SA LI	+ 378K4502SA RE
500 mm	53.804.96	-	-	378K5002SA LI	+ 378K5002SA RE
550 mm	-	-	-	378K5502SA LI	+ 378K5502SA RE
600 mm	-	-	-	378K6002SA LI	+ 378K6002SA RE
650 mm	-	-	-	378K6502SA LI	+ 378K6502SA RE

Abdeckkappen BLUM TANDEMBOX antaro

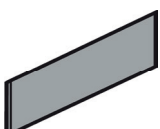

Kunststoff
Packung: 1/1000

Zargenhöhe	Systemhöhe	seidenweiss	grau RAL 9006	terraschwarz	Werks-Nr.
N/M/K	N/M/K/B/C/D	53.804.48	53.814.49	53.824.48	ZAA.532.CT

Holzrückwandhalter IP TANDEMBOX antaro

Lieferumfang:

- 50 Stück links/rechts
- für individuelle Breiten

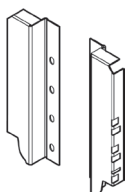
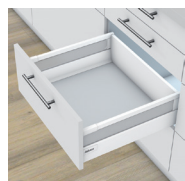
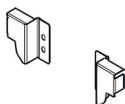

Schubkasten/Innenschubkasten

Zargenhöhe	Systemhöhe	seidenweiss	grau RAL 9006	terraschwarz	Werks-Nr.
M	M	53.800.62	53.810.62	-	Z30M000S.04

Frontschubkasten/Frontinnenschubkasten mit Reling

Zargenhöhe	Systemhöhe	seidenweiss	grau RAL 9006	terraschwarz	Werks-Nr.
M/K	C	53.802.35	53.812.37	-	Z30C000S.04
M/K	D	53.803.02	53.813.02	-	Z30D000S.04

Längsreling IP für Frontauszug BLUM TANDEMBOX antaro (links/rechts)

Packung:

- 64 Stück Reling links/rechts IP

für Systemhöhe B/C/D



Nennlänge	seidenweiss	grau RAL 9006	terraschwarz	links	rechts
				Werks-Nr.	Werks-Nr.
270 mm	-	-	-	-	-
300 mm	-	-	-	-	-
350 mm	-	-	-	-	-
400 mm	-	-	-	-	-
450 mm	53.802.15	-	-	ZRG.387RSIC L	+ ZRG.387RSIC R
500 mm	53.802.16	-	-	ZRG.437RSIC L	+ ZRG.437RSIC R
550 mm	53.802.17	-	-	ZRG.487RSIC L	+ ZRG.487RSIC R
600 mm	53.802.18	-	-	ZRG.537RSIC L	+ ZRG.537RSIC R
650 mm	53.802.19	-	-	ZRG.587RSIC L	+ ZRG.587RSIC R

Fronthalter IP für Vorderstück TANDEMBOX antaro Innenschubkasten (links/rechts)

Lieferumfang:

- 100 Stück Fronthalter links/rechts IP

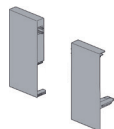

Korpusbreite	Zargenhöhe	Systemhöhe	seidenweiss	grau RAL 9006	terraschwarz	Werks-Nr.	Werks-Nr.
200-1200 mm	M	M	53.801.69	53.811.69	-	ZIF.71M0 L	+ ZIF.71M0 R
200-1200 mm	M	C	53.802.75	53.812.75	-	ZIF.74C0 L	+ ZIF.74C0 R

	Zargenhöhe	Systemhöhe	seidenweiss	grau RAL 9006	terraschwarz	Werks-Nr.
Halteteil	M/K	C/D	53.801.99	53.801.99	-	ZRG.000R5F
Relingkopf	M/K	C/D	53.822.19	53.822.19	-	ZRG.000R5F

Stahlrückwände



Zuschnitt – 16 mm Spanplatten

	Rückwandhöhe (mm)	69	84	116	167	199
	Systemhöhe (mm)	N	M	K	C	D
	Schubkastenboden					
	Holzrückwand NL – 24 mm					
Stahlrückwand NL – 22 mm						

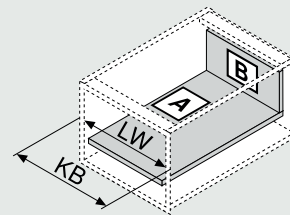

KB Korpusbreite
LW Lichte Korpusweite
NL Nennlänge

TANDEMBOX antaro Stahlrückwand

für Boden- Korpusseitenstärke 16 mm

Lieferumfang:

- 1 Stück

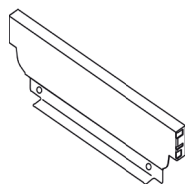

Systemhöhe N 68 mm

Stahlrückwände N für Standard Korpusbreiten

Korpusbreite	Zargenhöhe	seidenweiss	grau RAL 9006	terraschwarz	Werks-Nr.
275 mm	N	-	-	-	Z30N215S.6
300 mm	N	-	-	-	Z30N240S.6
350 mm	N	-	-	-	Z30N290S.6
400 mm	N	-	-	-	Z30N340S.6
450 mm	N	-	-	-	Z30N390S.6
500 mm	N	-	-	-	Z30N440S.6
550 mm	N	53.804.07	53.814.07	-	Z30N490S.6
600 mm	N	53.804.08	53.814.08	-	Z30N540S.6
800 mm	N	-	-	-	Z30N765S.6
900 mm	N	53.804.11	53.814.12	-	Z30N840S.6
1000 mm	N	-	-	-	Z30N940S.6
1100 mm	N	-	-	-	Z30N1040.6
1200 mm	N	-	-	-	Z30N1140.6

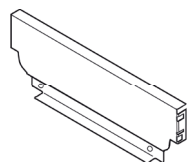

Systemhöhe M 83 mm

Stahlrückwände M für Standard Korpusbreiten

Korpusbreite	Zargenhöhe	seidenweiss	grau RAL 9006	terraschwarz	Werks-Nr.
275 mm	M	53.805.01	53.815.01	-	Z30M215S.6
300 mm	M	53.805.02	53.815.02	-	Z30M240S.6
350 mm	M	-	-	-	Z30M290S.6
400 mm	M	53.805.04	53.815.04	-	Z30M340S.6
450 mm	M	53.805.05	53.815.05	-	Z30M390S.6
500 mm	M	53.805.06	53.815.06	-	Z30M440S.6
550 mm	M	53.805.07	53.815.07	-	Z30M490S.6
600 mm	M	53.805.08	53.815.08	-	Z30M540S.6
800 mm	M	53.805.10	53.815.10	-	Z30M740S.6
900 mm	M	53.805.12	53.815.12	-	Z30M840S.6
1000 mm	M	53.805.13	-	-	Z30M940S.6
1100 mm	M	53.805.14	53.815.14	-	Z30M1040.6
1200 mm	M	53.805.15	53.815.15	-	Z30M1140.6

Rückwände/Stahlrückwände Müllauszug hängendes System

Zargenhöhe M 83 mm

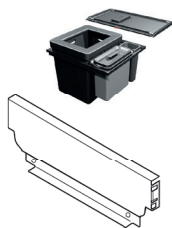

Stahlrückwände M für Müllauszug FRANKE Sorter 350 H - hängendes System (ohne Müllauszug)

Korpusbreite	Zargenhöhe	Seite	seidenweiss	grau RAL 9006	terraschwarz	Werks-Nr.
450 mm	M	16 mm	-	53.811.50	-	Z30M389SOW
550 mm	M	16 mm	-	53.811.55	-	Z30M489SOW
600 mm	M	16 mm	-	53.811.57	-	Z30M539SOW
900 mm	M	16 mm	-	53.811.54	-	Z30M839SOW
450 mm	M	19 mm	-	53.811.51	-	Z30M383SOW
550 mm	M	19 mm	-	53.811.56	-	Z30M483SOW
600 mm	M	19 mm	-	53.811.58	-	Z30M533SOW
900 mm	M	19 mm	-	53.811.59	-	Z30M883SOW

FRANKE Müllsystem 350 H siehe Seite 21

Systemhöhe C 192 mm

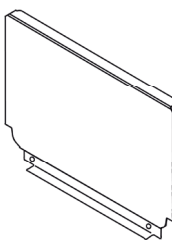

Stahlrückwände C für Standard Korpusbreiten

Korpusbreite	Zargenhöhe	seidenweiss	grau RAL 9006	terraschwarz	Werks-Nr.
275 mm	M/K	53.805.41	53.815.41	-	Z30C215S.6
300 mm	M/K	53.805.42	53.815.42	-	Z30C240S.6
350 mm	M/K	-	-	-	Z30C290S.6
400 mm	M/K	53.805.44	53.815.44	-	Z30C340S.6
450 mm	M/K	53.805.45	53.815.45	-	Z30C390S.6
500 mm	M/K	53.805.46	53.815.46	-	Z30C440S.6
550 mm	M/K	53.805.47	53.815.47	-	Z30C490S.6
600 mm	M/K	53.805.48	53.815.48	-	Z30C540S.6
800 mm	M/K	53.805.50	53.815.50	-	Z30C765S.6
900 mm	M/K	53.805.52	53.815.52	-	Z30C840S.6
1000 mm	M/K	53.805.53	53.815.53	-	Z30C940S.6
1100 mm	M/K	53.805.54	53.815.54	-	Z30C1040.6
1200 mm	M/K	53.805.55	53.815.55	-	Z30C1140.6

Systemhöhe D 224 mm

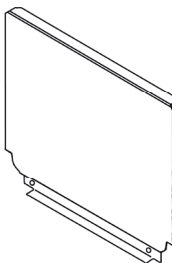

Stahlrückwände D für Standard Korpusbreiten

Korpusbreite	Zargenhöhe	seidenweiss	grau RAL 9006	terraschwarz	Werks-Nr.
275 mm	M/K	53.805.61	53.815.61	-	Z30D215S.6
300 mm	M/K	53.805.62	53.815.62	-	Z30D240S.6
350 mm	M/K	-	-	-	Z30D290S.6
400 mm	M/K	53.805.64	53.815.64	-	Z30D340S.6
450 mm	M/K	53.805.65	53.815.65	-	Z30D390S.6
500 mm	M/K	53.805.66	53.815.66	-	Z30D440S.6
550 mm	M/K	53.805.67	53.815.67	-	Z30D490S.6
600 mm	M/K	53.805.68	53.815.68	-	Z30D540S.6
800 mm	M/K	53.805.70	53.815.70	-	Z30D765S.6
900 mm	M/K	53.805.72	53.815.72	-	Z30D840S.6
1000 mm	M/K	53.805.73	53.815.73	-	Z30D940S.6
1100 mm	M/K	-	-	-	Z30D1040.6
1200 mm	M/K	-	53.815.75	-	Z30D1140.6

TANDEMBOX antaro

Längsreling/Einschubelemente

Längsreling für Frontauszug BLUM TANDEMBOX antaro



Lieferumfang:

- Längsreling rechts/links (Einzelpaar)

Nennlänge	Zargenhöhe	Systemhöhe	seidenweiss	grau RAL 9006	terraschwarz	Werks-Nr.
270 mm	M/K	B/C/D	53.802.01	53.812.01	53.822.01	ZRG.207RSIC
300 mm	M/K	B/C/D	53.802.02	53.812.02	53.822.02	ZRG.237RSIC
350 mm	M/K	B/C/D	53.802.03	53.812.03	53.822.03	ZRG.287RSIC
400 mm	M/K	B/C/D	53.802.04	53.812.04	53.822.04	ZRG.337RSIC
450 mm	M/K	B/C/D	53.802.05	53.812.05	53.822.05	ZRG.387RSIC
500 mm	M/K	B/C/D	53.802.06	53.812.06	53.822.06	ZRG.437RSIC
550 mm	M/K	B/C/D	53.802.07	53.812.07	53.822.07	ZRG.487RSIC
600 mm	M/K	B/C/D	53.802.08	53.812.08	53.822.08	ZRG.537RSIC
650 mm	M/K	B/C/D	53.802.09	53.812.09	53.822.09	ZRG.587RSIC

Halteteil-Set für Einschubelement BLUM TANDEMBOX antaro

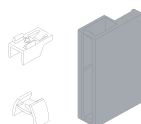

Lieferumfang:

- Halteteil links/rechts

Nennlänge	Zargenhöhe	Systemhöhe	seidenweiss	grau RAL 9006	terraschwarz	Werks-Nr.
270 - 650 mm	M	C	53.802.39	53.832.39	-	Z36C0080
270 - 650 mm	M	D	53.803.05	53.813.05	53.823.05	Z36D0080

Einschubelement (seitlich) für Frontauszug BLUM TANDEMBOX antaro

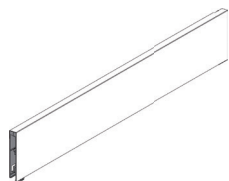

Lieferumfang:

- Stahleinschubelement, kürzbar (pro Schubkasten werden 2 Elemente benötigt)

Stahl	kürzbar	Zargenhöhe	Systemhöhe	seidenweiss	grau RAL 9006	terraschwarz	Werks-Nr.
450 mm	M	C	53.802.40	53.812.40	53.822.40	Z37A417C	
500 mm	M	C	53.802.41	53.812.41	53.822.41	Z37A467C	
550 mm	M	C	53.802.42	53.812.42	53.822.42	Z37A517C	
650 mm	M	C	53.802.43	53.812.43	53.822.43	Z37A617C	
450 mm	M	D	53.803.10	53.813.10	53.822.10	Z37A417D	
500 mm	M	D	53.803.11	53.813.11	53.822.11	Z37A467D	
550 mm	M	D	53.803.12	53.813.12	53.822.12	Z37A517D	
650 mm	M	D	53.803.13	53.813.13	53.822.13	Z37A617D	

Lieferumfang:

- Glaseinschubelement in Fixlängen (pro Schubkasten wird 1 Set benötigt)

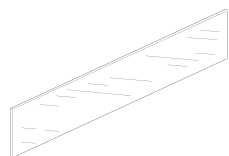

Glas	Fixlängen	Zargenhöhe	Systemhöhe	Glas satiniert	Glas klar	Werks-Nr.	Systemhöhe	Glas satiniert	Glas klar	Werks-Nr.
270 mm	M	D	53.803.21	53.803.31	Z37R237D	-	-	-	-	-
300 mm	M	D	53.803.22	53.803.32	Z37R267D	-	-	-	-	-
350 mm	M	D	53.803.23	53.803.33	Z37R317D	C	53.802.53	53.802.63	Z37R317C	
400 mm	M	D	53.803.24	53.803.34	Z37R367D	C	53.802.54	53.802.64	Z37R367C	
450 mm	M	D	53.803.25	53.803.35	Z37R417D	C	53.802.55	53.802.65	Z37R417C	
500 mm	M	D	53.803.26	53.803.36	Z37R467D	C	53.802.56	53.802.66	Z37R467C	
550 mm	M	D	53.803.27	53.803.37	Z37R517D	C	53.802.57	53.802.67	Z37R517C	
600 mm	M	D	53.803.28	53.803.38	Z37R567D	C	53.802.58	53.802.68	Z37R567C	
650 mm	M	D	53.803.29	53.803.39	Z37R617D	C	53.802.59	53.802.69	Z37R617C	

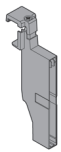
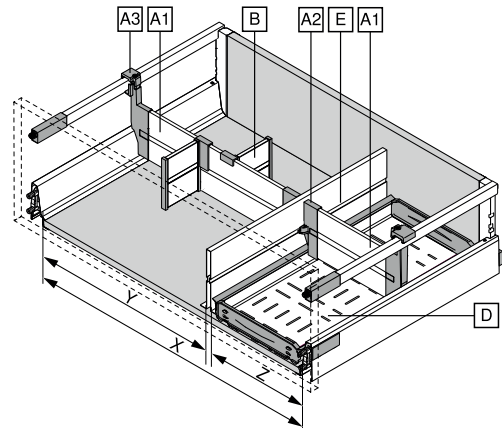

Querteilerprofil-Aufnahme BLUM ORGA-LINE für Reling mit Systemhöhe C

Nr.	Zargenhöhe	Systemhöhe	Nennlänge	seidenweiss	grau RAL 9006	terraschwarz	Werks-Nr.
A3	M/K	C	450 - 650 mm	53.912.11	53.912.13	53.912.14	Z40C0002Z

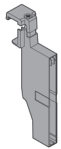

Querteilerprofil-Aufnahme BLUM ORGA-LINE für Reling mit Systemhöhe D

Nr.	Zargenhöhe	Systemhöhe	Nennlänge	seidenweiss	grau RAL 9006	terraschwarz	Werks-Nr.
A3	M/K	D	450 - 650 mm	53.912.21	53.912.23	53.912.24	Z40D0002Z

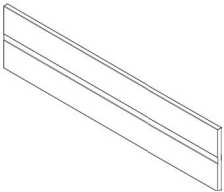

BLUM ORGA-LINE Querteilerprofil für TANDEMBOX antaro, Länge 1077 mm, Korpusbreite 1200 mm

Nr.	Zargenhöhe	Systemhöhe	Nennlänge	seidenweiss	grau RAL 9006	terraschwarz	Werks-Nr.
A1	M/K	C/D	450 - 650 mm	53.912.05	53.912.06	53.912.07	Z40L1077A

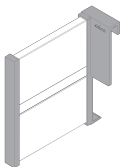

Längsteiler für BLUM ORGA-LINE

Nr.	Zargenhöhe	Systemhöhe	Nennlänge	seidenweiss	grau RAL 9006	terraschwarz	Werks-Nr.
B	M/K	C/D	450 - 650 mm	53.912.31	53.912.32	53.912.33	Z43L100S

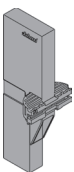

Querteilerprofil-Aufnahme BLUM ORGA-LINE an Zwischenwand

Nr.	Zargenhöhe	Systemhöhe	Nennlänge	seidenweiss	grau RAL 9006	terraschwarz	Werks-Nr.
A2	M/K	C/D	450 - 650 mm	53.912.01	53.912.03	53.912.04	Z40L0002

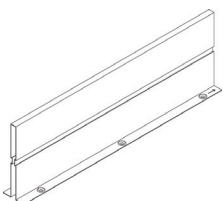

Zwischenwand BLUM ORGA-LINE

Nr.	Zargenhöhe	Systemhöhe	Nennlänge	seidenweiss	grau RAL 9006	terraschwarz	Werks-Nr.
E	M/K	C/D	450 mm	53.912.61	53.912.66	53.912.71	Z46L420S
	M/K	C/D	500 mm	53.912.62	53.912.67	53.912.72	Z46L470S
	M/K	C/D	550 mm	53.912.63	53.912.68	53.912.73	Z46L520S
	M/K	C/D	600 mm	53.912.64	53.912.69	53.912.74	Z46L570S
	M/K	C/D	650 mm	53.912.65	53.912.70	53.912.75	Z46L620S

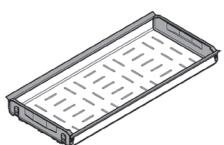

Flaschenwanne BLUM ORGA-LINE

Nr.	Zargenhöhe	Systemhöhe	Nennlänge	Korpusbreite	Edelstahl	terraschwarz	Werks-Nr.
D	M/K	C/D	500 mm	275 mm	53.912.43	-	Z48.27B016
	M/K	C/D	550 mm	275 mm	53.912.44	-	Z48.27B017
	M/K	C/D	500 mm	300 mm	53.912.52	-	Z48.30B016
	M/K	C/D	550 mm	300 mm	53.912.53	-	Z48.30B017

Schubkasten Innenorganisation ORGA-LINE über Reling

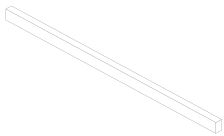
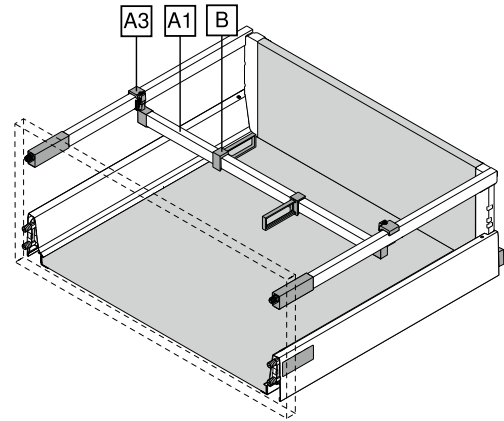

Querreling für TANDEMBOX antaro BLUM ORGA-LINE zum Ablängen, Länge 1104 mm

Nr.	Zargenhöhe	Systemhöhe	Nennlänge	seidenweiss	grau RAL 9006	terraschwarz	Werks-Nr.
A1	M/K	C/D	450 - 650 mm	53.912.85	53.912.86	53.912.87	ZRG.1104Q

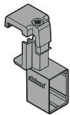

Querreling-Aufnahme BLUM ORGA-LINE

Nr.	Zargenhöhe	Systemhöhe	Nennlänge	seidenweiss	grau RAL 9006	terraschwarz	Werks-Nr.
A3	M/K	C/D	450 - 650 mm	53.912.90	53.912.91	53.912.93	ZRU.01E0

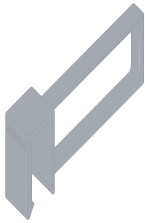

Längsteiler für Querreling BLUM ORGA-LINE

Nr.	Zargenhöhe	Systemhöhe	Nennlänge	seidenweiss	grau RAL 9006	terraschwarz	Werks-Nr.
B	M/K	C/D	450 - 650 mm	53.912.95	53.912.96	53.912.98	ZRU.11F0



Pfannendeckelhalter, seitlich

Nr.	Zargenhöhe	Systemhöhe	Nennlänge	seidenweiss	grau RAL 9006	terraschwarz	Werks-Nr.
-	M/K	C/D	500 - 650 mm	53.157.21	53.157.22	-	-



Flaschentrenngitter, seitlich, 4-teilig

Nr.	Zargenhöhe	Systemhöhe	Nennlänge	seidenweiss	grau RAL 9006	terraschwarz	Werks-Nr.
-	M/K	C/D	500 - 650 mm	53.157.11	53.157.12	-	-

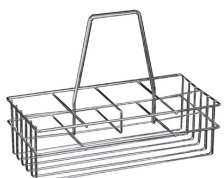

Flaschentragkorb BLUM 8-teilig

Nr.	Zargenhöhe	Systemhöhe	Nennlänge	B/H/T	seidenweiss	verchromt	terraschwarz
-	M/K	C/D	500 - 650 mm	191/310/410 mm	54.024.36	53.158.16	53.158.17

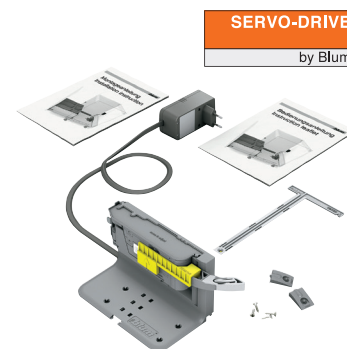

SERVO-DRIVE uno für stehende Müllösungen

Kehrriechtssystem MÜLLEX

Lieferumfang:

- Müllsystem inkl. Einlegeschale



Kehrriechtssystem MÜLLEX ZK-BOXX 55/60 BIO

OPO-Nr.	Korpusbreite	Nennlänge	Korpusseite	SERVO-DRIVE uno	Werks-Nr.
53.443.60	550 mm	450 mm	16 mm	53.915.61	Z10NA20EA01
53.443.61	600 mm	450 mm	16 mm		
-	550 mm	450 mm	19 mm		
53.443.62	600 mm	450 mm	19 mm		



Kehrriechtssystem MÜLLEX ZK-BOXX 55/60 City

OPO-Nr.	Korpusbreite	Nennlänge	Korpusseite	SERVO-DRIVE uno	Werks-Nr.
53.443.65	550 mm	450 mm	16 mm	53.915.61	Z10NA20EA01
53.443.67	600 mm	450 mm	16 mm		
53.443.66	550 mm	450 mm	19 mm		
53.443.68	600 mm	450 mm	19 mm		



Kehrriechtssystem MÜLLEX ZK-BOXX 40/45/50

OPO-Nr.	Korpusbreite	Nennlänge	Korpusseite	Mülleimer	SERVO-DRIVE uno	Werks-Nr.
53.443.84	400 mm	450 mm	16 mm	-	53.915.61	Z10NA20EA01
53.443.85	450 mm	450 mm	16 mm	-		
53.443.86	500 mm	450 mm	16 mm	links		
53.443.87	500 mm	450 mm	16 mm	rechts		
53.444.70	400 mm	450 mm	19 mm	-		
53.444.71	450 mm	450 mm	19 mm	-		
53.444.72	500 mm	450 mm	19 mm	links		



Kehrriechtssystem MÜLLEX EURO ZK-BOXX 55/60

OPO-Nr.	Korpusbreite	Nennlänge	Korpusseite	SERVO-DRIVE uno	Werks-Nr.
53.443.10	550 mm	450 mm	16 mm	53.915.61	Z10NA20EA01
53.443.12	600 mm	450 mm	16 mm		
53.443.11	550 mm	450 mm	19 mm		
53.443.13	600 mm	450 mm	19 mm		

Einbau-Müllsysteme für TANDEMBOX antaro mit Systemhöhe C oder D



Kehrachtsystem MÜLLEX EURO ZK-BOXX 40/45/50

OPO-Nr.	Korpusbreite	Nennlänge	Korpusseite	Mülleimer	SERVO-DRIVE uno	Werks-Nr.
53.443.96	400 mm	450 mm	16 mm	-	53.915.61	Z1ONA20EA01
53.443.97	450 mm	450 mm	16 mm	-		
53.443.98	500 mm	450 mm	16 mm	links		
53.443.99	500 mm	450 mm	16 mm	rechts		
53.444.74	400 mm	450 mm	19 mm	-		
53.444.75	450 mm	450 mm	19 mm	-		
53.444.76	500 mm	450 mm	19 mm	links		



Kehrachtsystem MÜLLEX ZK-TRIOXX 2 oder 3 x 16, 40/45/50/55/60

OPO-Nr.	Korpusbreite	Nennlänge	Korpusseite	TRIOXX	Mülleimer	SERVO-DRIVE uno	Werks-Nr.
53.444.15	400 mm	450 mm	16 mm	2 x 16	-	53.915.61	Z1ONA20EA01
53.444.16	450 mm	450 mm	16 mm	2 x 16	-		
53.444.17	500 mm	450 mm	16 mm	2 x 16	links		
53.444.18	500 mm	450 mm	16 mm	2 x 16	rechts		
53.444.05	550 mm	450 mm	16 mm	3 x 16	-		
53.444.07	600 mm	450 mm	16 mm	3 x 16	-		
53.444.22	400 mm	450 mm	19 mm	2 x 16	-		
53.444.23	450 mm	450 mm	19 mm	2 x 16	-		
53.444.24	500 mm	450 mm	19 mm	2 x 16	links		
53.444.06	550 mm	450 mm	19 mm	3 x 16	-		
53.444.08	600 mm	450 mm	19 mm	3 x 16	-		

Kehrachtsystem PEKA

Lieferumfang:

- Müllsystem inkl. Bodenmatte



Kehrachtsystem PEKA OekoUniversal 40+6+1.2

OPO-Nr.	Korpusbreite	Nennlänge	Korpusseite	SERVO-DRIVE uno	Werks-Nr.
53.433.22	550 mm	450 mm	16 mm	53.915.61	Z1ONA20EA01
53.433.26	600 mm	450 mm	16 mm		



Kehrachtsystem PEKA OekoUniversal 40+17

OPO-Nr.	Korpusbreite	Nennlänge	Korpusseite	SERVO-DRIVE uno	Werks-Nr.
53.433.32	600 mm	450 mm	16 mm	53.915.61	Z1ONA20EA01



Kehrachtsystem PEKA OekoUniversal 40

OPO-Nr.	Korpusbreite	Nennlänge	Korpusseite	SERVO-DRIVE uno	Werks-Nr.
53.433.42	450 mm	450 mm	16 mm	53.915.61	Z1ONA20EA01
53.433.46	500 mm	450 mm	16 mm		



Kehrachtsystem PEKA Oeko Universal Spider 40

OPO-Nr.	Korpusbreite	Nennlänge	Korpusseite	SERVO-DRIVE uno	Werks-Nr.
53.433.50	600 mm	450 mm	19 mm	53.915.61	Z1ONA20EA01
53.433.51	600 mm	450 mm	16 mm		



Kehrachtsystem PEKA Oeko Universal 40 Bag

OPO-Nr.	Korpusbreite	Nennlänge	Korpusseite	SERVO-DRIVE uno	Werks-Nr.
53.433.55	600 mm	450 mm	19 mm	53.915.61	Z1ONA20EA01
53.433.56	600 mm	450 mm	16 mm		

Kehrrichtsystem FRANKE



Kehrrichtsystem FRANKE-Sorter Serie 350 Composta

OPO-Nr.	Korpusbreite	Nennlänge	Korpusseite	Ausführung	SERVO-DRIVE uno	Werks-Nr.
53.428.20	550 mm	450 mm	16/19 mm	Systemdeckel	53.915.61	Z10NA20EA01
53.428.21	550 mm	450 mm	16/19 mm	Auszugschublade		
53.428.22	600 mm	450 mm	16/19 mm	Systemdeckel		
53.428.23	600 mm	450 mm	16/19 mm	Auszugschublade		
53.428.24	600 mm	450 mm	16/19 mm	Systemdeckel Euro		
53.428.25	600 mm	450 mm	16/19 mm	Auszugschublade Euro		



Kehrrichtsystem FRANKE-Sorter Serie 350 Varia

OPO-Nr.	Korpusbreite	Nennlänge	Korpusseite	Ausführung	SERVO-DRIVE uno	Werks-Nr.
53.428.35	550 mm	450 mm	16/19 mm	Systemdeckel	53.915.61	Z10NA20EA01
53.428.36	550 mm	450 mm	16/19 mm	Auszugschublade		
53.428.37	600 mm	450 mm	16/19 mm	Systemdeckel		
53.428.38	600 mm	450 mm	16/19 mm	Auszugschublade		



Kehrrichtsystem FRANKE-Sorter Serie 350 Typ 40/45/50

OPO-Nr.	Korpusbreite	Nennlänge	Korpusseite	Ausführung	SERVO-DRIVE uno	Werks-Nr.
53.428.30	400 mm	450 mm	16/19 mm	Systemdeckel	53.915.61	Z10NA20EA01
53.428.31	450 mm	450 mm	16/19 mm	Systemdeckel		
53.428.32	500 mm	450 mm	16/19 mm	Systemdeckel		
53.428.33	500 mm	450 mm	16/19 mm	Auszugschublade		

SERVO-DRIVE
by Blum

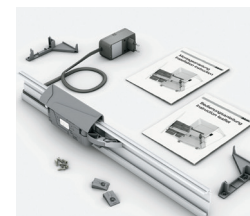

SERVO-DRIVE uno für
hängende Müllösungen



Kehrrichtsystem FRANKE-Sorter Serie 350 H Composta 60

OPO-Nr.	Korpusbreite	Nennlänge	Korpusseite	Ausführung	SERVO-DRIVE uno	Werks-Nr.
53.428.42	600 mm	450 mm	16/19 mm	Systemdeckel	53.915.73	Z10T493WEA1
53.428.43	600 mm	450 mm	16/19 mm	Auszugschublade		



Kehrrichtsystem FRANKE-Sorter Serie 350 H Varia

OPO-Nr.	Korpusbreite	Nennlänge	Korpusseite	Ausführung	SERVO-DRIVE uno	Werks-Nr.
53.428.44	600 mm	450 mm	16/19 mm	Systemdeckel	53.915.73	Z10T493WEA1
53.428.45	600 mm	450 mm	16/19 mm	Auszugschublade		



Kehrrichtsystem FRANKE-Sorter Serie 350 H Varia

OPO-Nr.	Korpusbreite	Nennlänge	Korpusseite	Ausführung	SERVO-DRIVE uno	Werks-Nr.
53.428.40	550 mm	450 mm	16/19 mm	Systemdeckel	53.915.73	Z10T493WEA1
53.428.41	550 mm	450 mm	16/19 mm	Auszugschublade		

Stahlrückwände M für hängendes System siehe Seite 15

Schubkasten Innenorganisation MOVE



Besteckeinsatz 300				
Material	Farbe	Belegungsart	Systemhöhe	OPO-Nr.
Massivholz	Eiche	natur lackiert	Systemhöhe	OPO-Nr.
M/K	53.042.01	Nennlänge	Breite	Höhe
		500 mm	300 mm	43 mm



Alu Clip MOVE				
Material	Farbe	Belegungsart	Systemhöhe	OPO-Nr.
Aluminium	natur eloxiert	Systemhöhe	OPO-Nr.	
M/K	53.042.14	Tiefe	Breite	Höhe
		14 mm	40 mm	9 mm



Schale				
Material	Farbe	Belegungsart	Systemhöhe	OPO-Nr.
Massivholz	Eiche	natur lackiert	Systemhöhe	OPO-Nr.
M/K	53.042.02	Nennlänge*	Breite	Höhe
		500 mm	300 mm	43 mm



Schalenunterteiler				
Material	Farbe	Belegungsart	Systemhöhe	OPO-Nr.
Stahl	schwarz graphit	Systemhöhe	OPO-Nr.	
M/K	53.042.15	Tiefe	Breite	Höhe
		111 mm	106 mm	38 mm

* 4 Schalen mit Tiefe 118 mm ergeben Nennlänge 500 mm



Tiefenergänzungsmodul Nennlänge 550 mm				
Material	Farbe	Belegungsart	Systemhöhe	OPO-Nr.
Massivholz	Eiche	natur lackiert	Systemhöhe	OPO-Nr.
M/K	53.042.19	Tiefe	Breite	Höhe
		50 mm	600 mm	43 mm
M/K	53.042.20	50 mm	1200 mm	43 mm



Multifunktionseinsatz 150				
Material	Farbe	Belegungsart	Systemhöhe	OPO-Nr.
Massivholz	Eiche	natur lackiert	Systemhöhe	OPO-Nr.
M/K	53.042.03	Nennlänge	Breite	Höhe
		500 mm	150 mm	43 mm



Einsatz Kreuz				
Material	Farbe	Belegungsart	Systemhöhe	OPO-Nr.
Massivholz	Eiche	natur lackiert	Systemhöhe	OPO-Nr.
M/K	53.042.06	Nennlänge	Breite	Höhe
		500 mm	137 mm	38 mm



Gewürzeinlage schräg, 3-tlg				
Material	Farbe	Belegungsart	Systemhöhe	OPO-Nr.
Massivholz	Eiche	natur lackiert	Systemhöhe	OPO-Nr.
M/K	53.042.07	Nennlänge	Breite	Höhe
		500 mm	137 mm	27 mm



Folienhalter				
Material	Farbe	Belegungsart	Systemhöhe	OPO-Nr.
Massivholz	Eiche	natur lackiert	Systemhöhe	OPO-Nr.
M/K	53.042.05	Nennlänge	Breite	Höhe
		500 mm	137 mm	38 mm



Messerblock				
Material	Farbe	Belegungsart	Systemhöhe	OPO-Nr.
Massivholz	Eiche	natur lackiert	Systemhöhe	OPO-Nr.
M/K	53.042.04	Nennlänge	Breite	Höhe
		500 mm	187 mm	26 mm



Gewürzeinlage gross				
Material	Farbe	Belegungsart	Systemhöhe	OPO-Nr.
Massivholz	Eiche	natur lackiert	Systemhöhe	OPO-Nr.
M/K	53.042.08	Nennlänge	Breite	Höhe
		500 mm	137 mm	8 mm



Gewürzstreuer			
Material	Farbe	Systemhöhe	OPO-Nr.
Edelstahl	gebürstet/matt	Systemhöhe	OPO-Nr.
Streuer		Breite	Höhe
1 Grobstreuer		53.040.11	ø 60 mm 62 mm
2 Feinstreuer		53.040.12	ø 60 mm 62 mm
3 Salzstreuer		53.040.13	ø 60 mm 62 mm
4 Pfefferstreuer		53.040.14	ø 60 mm 62 mm
5 Dose mit Deckel		53.040.15	ø 60 mm 62 mm
6 Netzstreuer		53.040.16	ø 60 mm 57 mm



Einsatzschale Bowl

Material	Farbe	Finish	Systemhöhe	OPO-Nr.	Nennlänge*	Breite	Höhe
Massivholz	Eiche	natur lackiert	M/K	53.042.21	500 mm	300 mm	43 mm

* 2 Schalen mit Tiefe 236 mm ergeben Nennlänge 500 mm



Filzeinlegematte Bowl

Material	Farbe	Systemhöhe	OPO-Nr.	Tiefe	Breite	Höhe
Filz	natur	M/K	53.042.23	223 mm	287 mm	3 mm



Kreuzesatz Bowl

Material	Farbe	Finish	Systemhöhe	OPO-Nr.	Tiefe	Breite	Höhe
Massivholz	Eiche	natur lackiert	M/K	53.042.22	423 mm	287 mm	36 mm



Filzeinlegematte

Material	Farbe	Systemhöhe	OPO-Nr.	Nennlänge	Breite	Höhe
Filz	natur	M/K/C/F	53.042.24	500 mm	1200 mm	3 mm



Box 1 für Frontschubkasten

Material	Farbe	Finish	Systemhöhe	OPO-Nr.	Nennlänge	Breite	Höhe
Massivholz	Eiche	natur lackiert	C/F	53.042.10	500 mm	236 mm	110 mm



Box 2 für Frontschubkasten

Material	Farbe	Finish	Systemhöhe	OPO-Nr.	Nennlänge*	Breite	Höhe
Massivholz	Eiche	natur lackiert	C/F	53.042.11	500 mm	136 mm	110 mm

* 2 Boxen mit Tiefe 236 mm ergeben Nennlänge 500 mm



U-Teiler mit Griff Box 1+2

Material	Farbe	Finish	Systemhöhe	OPO-Nr.	Tiefe	Breite	Höhe
Stahl	schwarz graphit	C/F	53.042.17	219 mm	99 mm	102 mm	



Box 3 für Frontschubkasten

Material	Farbe	Finish	Systemhöhe	OPO-Nr.	Nennlänge*	Breite	Höhe
Massivholz	Eiche	natur lackiert	C/F	53.042.12	500 mm	236 mm	43 mm

* 2 Boxen mit Tiefe 236 mm ergeben Nennlänge 500 mm

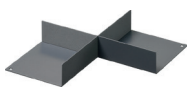

Auskreuzung Box 2 + 3

Material	Farbe	Finish	Systemhöhe	OPO-Nr.	Tiefe	Breite	Höhe
Stahl	schwarz graphit	C/F	53.042.16	223 mm	223 mm	38 mm	



Box 4 Oberschrank

Material	Farbe	Finish	Korpusbreite	OPO-Nr.	Tiefe	Breite	Höhe
Massivholz	Eiche	natur lackiert	275-1200 mm	53.042.13	300 mm	118 mm	90 mm

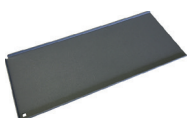

Oberschrankrutsche für Box 4

Material	Farbe	Finish	Korpusbreite	OPO-Nr.	Tiefe	Breite	Höhe
Stahl	schwarz graphit	M/K	275-1200 mm	53.042.18	302 mm	121 mm	6 mm

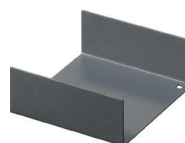

Schalenunterteiler

Material	Farbe	Finish	Systemhöhe	OPO-Nr.	Tiefe	Breite	Höhe
Stahl	schwarz graphit	M/K	53.042.15	111 mm	106 mm	38 mm	

Schubkasten Innenorganisation MOVE

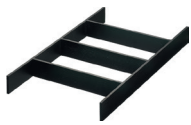
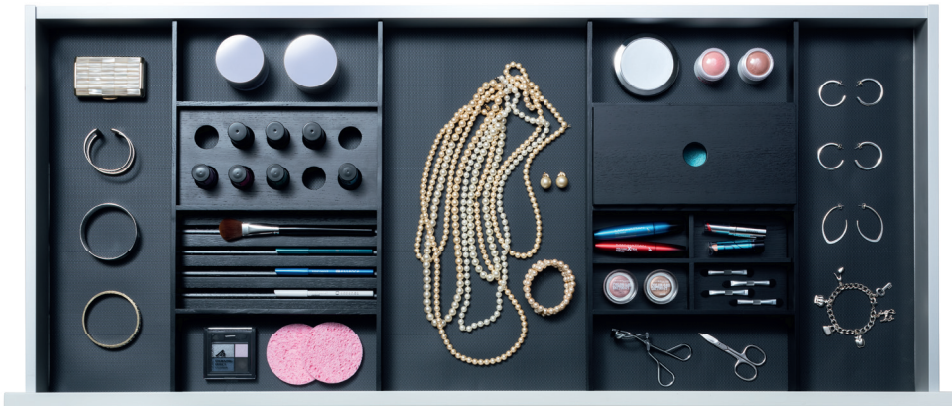

Einsetzrahmen tief, Tiefe 472 mm					
Systemhöhe	OPO-Nr.	Nennlänge	Breite	Höhe	
M/K	53.042.29	500 mm	268 mm	43 mm	



Lippenstifteinsatz Bohrø 30 mm					
Systemhöhe	OPO-Nr.	Tiefe	Breite	Höhe	
M/K	53.042.31	125 mm	255 mm	29 mm	



Kreuzeseinsatz tief					
Systemhöhe	OPO-Nr.	Tiefe	Breite	Höhe	
M/K	53.042.32	125 mm	255 mm	29 mm	

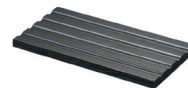

Schminkstifteinsatz					
Systemhöhe	OPO-Nr.	Tiefe	Breite	Höhe	
M/K	53.042.33	125 mm	255 mm	12 mm	



Einsatzschale tief					
Systemhöhe	OPO-Nr.	Tiefe	Breite	Höhe	
M/K	53.042.34	125 mm	255 mm	55 mm	



Einsetzrahmen hoch, Tiefe 472 mm					
Systemhöhe	OPO-Nr.	Nennlänge	Breite	Höhe	
C/F	53.042.39	500 mm	276 mm	110 mm	



Einsatzbox hoch					
Systemhöhe	OPO-Nr.	Tiefe	Breite	Höhe	
C/F	53.042.37	129 mm	259 mm	156 mm	



Kreuzeseinsatz hoch					
Systemhöhe	OPO-Nr.	Tiefe	Breite	Höhe	
C/F	53.042.38	129 mm	259 mm	100 mm	



Deckel zu Einsatzschale hoch/tief					
Systemhöhe	OPO-Nr.	Tiefe	Breite	Höhe	
M/K/C/F	53.042.35	125 mm	255 mm	8 mm	



Siphon-Organisations-System banio, Nennlänge 270 - 500 mm					
Systemhöhe	seidenweiss	oriongrau	terraschwarz	transluzent	
M/K	53.066.50	53.066.51	53.066.52	-	
Behälter (3 Schalen)	-	-	-	53.066.55	



Schalen-Set BLUM ORGA-LINE TANDEMBOX antaro für Schubkasten



OPO-Nr.	Nennlänge	Korpusbreite	Systemhöhe	Werks-Nr.	Werks-Nr.
53.914.05	450 mm	275 - 299 mm	M/K	ZSI.450B11N IG/G	-
53.914.06	500 mm	275 - 299 mm	M/K	ZSI.500B11N IG/G	-
53.914.07	550 mm	275 - 299 mm	M/K	ZSI.550B11N IG/G	-
53.914.08	600 mm	275 - 299 mm	M/K	ZSI.600B11N IG/G	-
53.914.09	650 mm	275 - 299 mm	M/K	ZSI.650B11N IG/G	-



OPO-Nr.	Nennlänge	Korpusbreite	Systemhöhe	Werks-Nr.	Werks-Nr.
53.914.15	450 mm	300 - 399 mm	M/K	ZSI.450B12N IG/G	-
53.914.16	500 mm	300 - 399 mm	M/K	ZSI.500B12N IG/G	-
53.914.17	550 mm	300 - 399 mm	M/K	ZSI.550B12N IG/G	-
53.914.18	600 mm	300 - 399 mm	M/K	ZSI.600B12N IG/G	-
53.914.19	650 mm	300 - 399 mm	M/K	ZSI.650B12N IG/G	-



OPO-Nr.	Nennlänge	Korpusbreite	Systemhöhe	Werks-Nr.	Werks-Nr.
53.914.35	450 mm	400 - 549 mm	M/K	ZSI.450B13N IG/G	-
53.914.36	500 mm	400 - 549 mm	M/K	ZSI.500B12N IG/G	-
53.914.37	550 mm	400 - 549 mm	M/K	ZSI.550B12N IG/G	-
53.914.38	600 mm	400 - 549 mm	M/K	ZSI.600B12N IG/G	-
53.914.39	650 mm	400 - 549 mm	M/K	ZSI.650B12N IG/G	-



OPO-Nr.	Nennlänge	Korpusbreite	Systemhöhe	Werks-Nr.	Werks-Nr.
53.914.45	450 mm	550 - 599 mm	M/K	ZSI.450B11N IG/G	+ ZSI.450B13N IG/G
53.914.46	500 mm	550 - 599 mm	M/K	ZSI.500B11N IG/G	+ ZSI.500B12N IG/G
53.914.47	550 mm	550 - 599 mm	M/K	ZSI.550B11N IG/G	+ ZSI.550B12N IG/G
53.914.48	600 mm	550 - 599 mm	M/K	ZSI.600B11N IG/G	-
53.914.49	650 mm	550 - 599 mm	M/K	ZSI.650B11N IG/G	-



OPO-Nr.	Nennlänge	Korpusbreite	Systemhöhe	Werks-Nr.	Werks-Nr.
53.914.55	450 mm	600 mm	M/K	ZSI.60VE14 IG/G	-
53.914.56	500 mm	600 mm	M/K	ZSI.60VE16 IG/G	-
53.914.57	550 mm	600 mm	M/K	ZSI.60VE17 IG/G	-
53.914.58	600 mm	600 mm	M/K	ZSI.600B11N IG/G	+ ZSI.600B13 IG/G
53.914.59	650 mm	600 mm	M/K	ZSI.650B11N IG/G	+ ZSI.650B13 IG/G

Schubkasten Innenorganisation

ORGA-LINE Edelstahl-Design



OPO-Nr.	Nennlänge	Korpusbreite	Systemhöhe	Werks-Nr.	Werks-Nr.
53.914.65	450 mm	601 - 699 mm	M/K	ZSI.450B11N IG/G	+ ZSI.450B13N IG/G
53.914.66	500 mm	601 - 699 mm	M/K	ZSI.500B11N IG/G	+ ZSI.500B12N IG/G
53.914.67	550 mm	601 - 699 mm	M/K	ZSI.550B11N IG/G	+ ZSI.550B12N IG/G
53.914.68	600 mm	601 - 699 mm	M/K	ZSI.600B11N IG/G	+ ZSI.600B12N IG/G
53.914.69	650 mm	601 - 699 mm	M/K	ZSI.650B11N IG/G	+ ZSI.650B12N IG/G



OPO-Nr.	Nennlänge	Korpusbreite	Systemhöhe	Werks-Nr.	Werks-Nr.
53.914.75	450 mm	700 - 799 mm	M/K	ZSI.450B12N IG/G	+ ZSI.450B13N IG/G
53.914.76	500 mm	700 - 799 mm	M/K	ZSI.500B12N IG/G	+ ZSI.500B12N IG/G
53.914.77	550 mm	700 - 799 mm	M/K	ZSI.550B12N IG/G	+ ZSI.550B12N IG/G
53.914.78	600 mm	700 - 799 mm	M/K	ZSI.600B12N IG/G	+ ZSI.600B12N IG/G
53.914.79	650 mm	700 - 799 mm	M/K	ZSI.650B12N IG/G	+ ZSI.650B12N IG/G



OPO-Nr.	Nennlänge	Korpusbreite	Systemhöhe	Werks-Nr.	Werks-Nr.
53.914.85	450 mm	801 - 899 mm	M/K	2 x ZSI.450B13N IG/G	-
53.914.86	500 mm	801 - 899 mm	M/K	2 x ZSI.500B12N IG/G	-
53.914.87	550 mm	801 - 899 mm	M/K	2 x ZSI.550B12N IG/G	-
53.914.88	600 mm	801 - 899 mm	M/K	2 x ZSI.600B12N IG/G	-
53.914.89	650 mm	801 - 899 mm	M/K	2 x ZSI.650B12N IG/G	-



OPO-Nr.	Nennlänge	Korpusbreite*	Systemhöhe	Werks-Nr.	Werks-Nr.
53.914.95	450 mm	900 mm	M/K	ZSI.90VEI4 IG/G	-
53.914.96	500 mm	900 mm	M/K	ZSI.90VEI6 IG/G	-
53.914.97	550 mm	900 mm	M/K	ZSI.90VEI7 IG/G	-
53.914.98	600 mm	900 mm	M/K	ZSI.600B12N IG/G	+ ZSI.600K14 IG/G
53.914.99	650 mm	900 mm	M/K	ZSI.650B12N IG/G	+ ZSI.650K14 IG/G



OPO-Nr.	Nennlänge	Korpusbreite*	Systemhöhe	Werks-Nr.	Werks-Nr.
53.916.05	450 mm	901 - 999 mm	M/K	ZSI.450B13N IG/G	+ ZSI.450K14N IG/G
53.916.06	500 mm	901 - 999 mm	M/K	ZSI.500B12N IG/G	+ ZSI.500K14 IG/G
53.916.07	550 mm	901 - 999 mm	M/K	ZSI.550B12N IG/G	+ ZSI.550K14 IG/G
53.916.08	600 mm	901 - 999 mm	M/K	ZSI.600B12N IG/G	+ ZSI.600K14 IG/G
53.916.09	650 mm	901 - 999 mm	M/K	ZSI.650B12N IG/G	+ ZSI.650K14 IG/G



OPO-Nr.	Nennlänge	Korpusbreite*	Systemhöhe	Werks-Nr.	Werks-Nr.
53.916.15	450 mm	1000 - 1099 mm	M/K	2 x ZSI.450K14N IG/G	-
53.916.16	500 mm	1000 - 1099 mm	M/K	2 x ZSI.500K14 IG/G	-
53.916.17	550 mm	1000 - 1099 mm	M/K	2 x ZSI.550K14 IG/G	-
53.916.18	600 mm	1000 - 1099 mm	M/K	2 x ZSI.600K14 IG/G	-
53.916.19	650 mm	1000 - 1099 mm	M/K	2 x ZSI.650K14 IG/G	-



OPO-Nr.	Nennlänge	Korpusbreite*	Systemhöhe	Werks-Nr.	Werks-Nr.
53.916.25	450 mm	1100 - 1199 mm	M/K	2 x ZSI.450B13N IG/G	+ ZSI.450F12N IG/G
53.916.26	500 mm	1100 - 1199 mm	M/K	2 x ZSI.500B12N IG/G	+ ZSI.500F12N IG/G
53.916.27	550 mm	1100 - 1199 mm	M/K	2 x ZSI.550B12N IG/G	+ ZSI.550F12N IG/G
53.916.28	600 mm	1100 - 1199 mm	M/K	2 x ZSI.600B12N IG/G	+ ZSI.600F12N IG/G
53.916.29	650 mm	1100 - 1199 mm	M/K	2 x ZSI.650B12N IG/G	+ ZSI.650F12N IG/G



OPO-Nr.	Nennlänge	Korpusbreite*	Systemhöhe	Werks-Nr.	Werks-Nr.
53.916.36	500 mm	1200 mm	M/K	ZSI.12VEI6 IG/G	-
53.916.37	550 mm	1200 mm	M/K	ZSI.12VEI7 IG/G	-
53.916.38	600 mm	1200 mm	M/K	2 x ZSI.600B12N IG/G	+ ZSI.600F12N IG/G
53.916.39	650 mm	1200 mm	M/K	2 x ZSI.650B12N IG/G	+ ZSI.650F12N IG/G

* Fach 1: Alu- oder Frischhaltefolienhalter einsetzbar

Fach 2: Messerhalter oder Alu- und Frischhaltefolienhalter in Kombination einsetzbar siehe Seite 32



Fach-Set BLUM ORGA-LINE TANDEMBOX antaro für Schubkasten



OPO-Nr.	Nennlänge	Korpusbreite	Systemhöhe	Werks-Nr.	Werks-Nr.
53.917.45	450 mm	275 - 349 mm	M/K	ZSI.450B11N IG/G	-
53.917.46	500 mm	275 - 349 mm	M/K	ZSI.500B11N IG/G	-
53.917.47	550 mm	275 - 349 mm	M/K	ZSI.550B11N IG/G	-
53.917.48	600 mm	275 - 349 mm	M/K	ZSI.600B11N IG/G	-
53.917.49	650 mm	275 - 349 mm	M/K	ZSI.650B11N IG/G	-



OPO-Nr.	Nennlänge	Korpusbreite*	Systemhöhe	Werks-Nr.	Werks-Nr.
53.917.55	450 mm	350 - 449 mm	M/K	ZSI.450K12N IG/G	-
53.917.56	500 mm	350 - 449 mm	M/K	ZSI.500K12N IG/G	-
53.917.57	550 mm	350 - 449 mm	M/K	ZSI.550K12N IG/G	-
53.917.58	600 mm	350 - 449 mm	M/K	ZSI.600K12N IG/G	-
53.917.59	650 mm	350 - 449 mm	M/K	ZSI.650K12N IG/G	-



OPO-Nr.	Nennlänge	Korpusbreite*	Systemhöhe	Werks-Nr.	Werks-Nr.
53.917.65	450 mm	450 - 599 mm	M/K	ZSI.450F12N IG/G	-
53.917.66	500 mm	450 - 599 mm	M/K	ZSI.500F12N IG/G	-
53.917.67	550 mm	450 - 599 mm	M/K	ZSI.550F12N IG/G	-
53.917.68	600 mm	450 - 599 mm	M/K	ZSI.600F12N IG/G	-
53.917.69	650 mm	450 - 599 mm	M/K	ZSI.650F12N IG/G	-

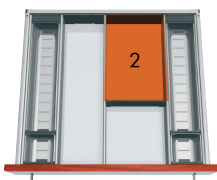

OPO-Nr.	Nennlänge	Korpusbreite*	Systemhöhe	Werks-Nr.	Werks-Nr.
53.917.75	450 mm	600 mm	M/K	ZSI.60VU14 IG/G	-
53.917.76	500 mm	600 mm	M/K	ZSI.60VU16 IG/G	-
53.917.77	550 mm	600 mm	M/K	ZSI.60VU17 IG/G	-
53.917.78	600 mm	600 mm	M/K	ZSI.600B11N IG/G	+ ZSI.600K13N IG/G
53.917.79	650 mm	600 mm	M/K	ZSI.650B11N IG/G	+ ZSI.650K13N IG/G

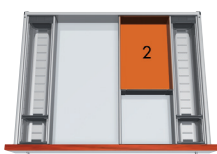

OPO-Nr.	Nennlänge	Korpusbreite*	Systemhöhe	Werks-Nr.	Werks-Nr.
53.917.85	450 mm	601 - 699 mm	M/K	ZSI.450B11N IG/G	+ ZSI.450K13N IG/G
53.917.86	500 mm	601 - 699 mm	M/K	ZSI.500B11N IG/G	+ ZSI.500K13N IG/G
53.917.87	550 mm	601 - 699 mm	M/K	ZSI.550B11N IG/G	+ ZSI.550K13N IG/G
53.917.88	600 mm	601 - 699 mm	M/K	ZSI.600B11N IG/G	+ ZSI.600K13N IG/G
53.917.89	650 mm	601 - 699 mm	M/K	ZSI.650B11N IG/G	+ ZSI.650K13N IG/G

* Fach 1: Alu- oder Frischhaltefolienhalter einsetzbar

Fach 2: Messerhalter oder Alu- und Frischhaltefolienhalter in Kombination einsetzbar siehe Seite 32

Schubkasten Innenorganisation

ORGA-LINE Edelstahl-Design



OPO-Nr.	Nennlänge	Korpusbreite*	Systemhöhe	Werks-Nr.	Werks-Nr.
53.917.95	450 mm	700 - 799 mm	M/K	ZSI.450KI2N IG/G	+ ZSI.450KI3N IG/G
53.917.96	500 mm	700 - 799 mm	M/K	ZSI.500KI2N IG/G	+ ZSI.500KI3N IG/G
53.917.97	550 mm	700 - 799 mm	M/K	ZSI.550KI2N IG/G	+ ZSI.550KI3N IG/G
53.917.98	600 mm	700 - 799 mm	M/K	ZSI.600KI2N IG/G	+ ZSI.600KI3N IG/G
53.917.99	650 mm	700 - 799 mm	M/K	ZSI.650KI2N IG/G	+ ZSI.650KI3N IG/G



OPO-Nr.	Nennlänge	Korpusbreite*	Systemhöhe	Werks-Nr.	Werks-Nr.
53.918.05	450 mm	800 - 899 mm	M/K	2x ZSI.450KI3N IG/G	-
53.918.06	500 mm	800 - 899 mm	M/K	2x ZSI.500KI3N IG/G	-
53.918.07	550 mm	800 - 899 mm	M/K	2x ZSI.550KI3N IG/G	-
53.918.08	600 mm	800 - 899 mm	M/K	2x ZSI.600KI3N IG/G	-
53.918.09	650 mm	800 - 899 mm	M/K	2x ZSI.650KI3N IG/G	-

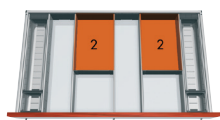

OPO-Nr.	Nennlänge	Korpusbreite*	Systemhöhe	Werks-Nr.	Werks-Nr.
53.918.15	450 mm	900 mm	M/K	ZSI.90VUI4 IG/G	-
53.918.16	500 mm	900 mm	M/K	ZSI.90VUI6 IG/G	-
53.918.17	550 mm	900 mm	M/K	ZSI.90VUI7 IG/G	-
53.918.18	600 mm	900 mm	M/K	2x ZSI.600KI3N IG/G	-
53.918.19	650 mm	900 mm	M/K	2x ZSI.650KI3N IG/G	-

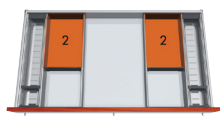

OPO-Nr.	Nennlänge	Korpusbreite*	Systemhöhe	Werks-Nr.	Werks-Nr.
53.918.25	450 mm	901 - 999 mm	M/K	2x ZSI.450KI3N IG/G	-
53.918.26	500 mm	901 - 999 mm	M/K	2x ZSI.500KI3N IG/G	-
53.918.27	550 mm	901 - 999 mm	M/K	2x ZSI.550KI3N IG/G	-
53.918.28	600 mm	901 - 999 mm	M/K	2x ZSI.600KI3N IG/G	-
53.918.29	650 mm	901 - 999 mm	M/K	2x ZSI.650KI3N IG/G	-

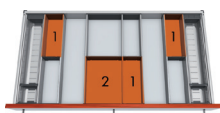

OPO-Nr.	Nennlänge	Korpusbreite*	Systemhöhe	Werks-Nr.	Werks-Nr.
53.918.35	450 mm	1000 - 1099 mm	M/K	2x ZSI.450KI2N IG/G	+ ZSI.450FI3 IG/G
53.918.36	500 mm	1000 - 1099 mm	M/K	2x ZSI.500KI2N IG/G	+ ZSI.500FI3 IG/G
53.918.37	550 mm	1000 - 1099 mm	M/K	2x ZSI.550KI2N IG/G	+ ZSI.550FI3 IG/G
53.918.38	600 mm	1000 - 1099 mm	M/K	2x ZSI.600KI2N IG/G	+ ZSI.600FI3 IG/G
53.918.39	650 mm	1000 - 1099 mm	M/K	2x ZSI.650KI2N IG/G	+ ZSI.650FI3 IG/G

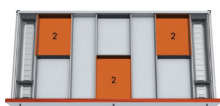

OPO-Nr.	Nennlänge	Korpusbreite*	Systemhöhe	Werks-Nr.	Werks-Nr.
53.918.45	450 mm	1100 - 1199 mm	M/K	2x ZSI.450KI3N IG/G	+ ZSI.450FI2N IG/G
53.918.46	500 mm	1100 - 1199 mm	M/K	2x ZSI.500KI3N IG/G	+ ZSI.500FI2N IG/G
53.918.47	550 mm	1100 - 1199 mm	M/K	2x ZSI.550KI3N IG/G	+ ZSI.550FI2N IG/G
53.918.48	600 mm	1100 - 1199 mm	M/K	2x ZSI.600KI3N IG/G	+ ZSI.600FI2N IG/G
53.918.49	650 mm	1100 - 1199 mm	M/K	2x ZSI.650KI3N IG/G	+ ZSI.650FI2N IG/G



OPO-Nr.	Nennlänge	Korpusbreite*	Systemhöhe	Werks-Nr.	Werks-Nr.
53.918.55	450 mm	1200 mm	M/K	ZSI.12VUI4 IG/G	-
53.918.56	500 mm	1200 mm	M/K	ZSI.12VUI6 IG/G	-
53.918.57	550 mm	1200 mm	M/K	ZSI.12VUI7 IG/G	-
53.918.58	600 mm	1200 mm	M/K	2x ZSI.600KI3N IG/G	+ ZSI.600FI3 IG/G
53.918.59	650 mm	1200 mm	M/K	2x ZSI.650KI3N IG/G	+ ZSI.650FI3 IG/G

* Fach 1: Alu- oder Frischhaltefolienhalter einsetzbar

Fach 2: Messerhalter oder Alu- und Frischhaltefolienhalter in Kombination einsetzbar siehe Seite 32



Kombi-Set BLUM ORGA-LINE TANDEMBOX antaro für Schubkasten

	OPO-Nr.	Nennlänge	Korpusbreite	Systemhöhe	Werks-Nr.	Werks-Nr.
	53.918.65	450 mm	275 - 349 mm	M/K	ZSI.450B11N IG/G	-
	53.918.66	500 mm	275 - 349 mm	M/K	ZSI.500B11N IG/G	-
	53.918.67	550 mm	275 - 349 mm	M/K	ZSI.550B11N IG/G	-
	53.918.68	600 mm	275 - 349 mm	M/K	ZSI.600B11N IG/G	-
53.918.69	650 mm	275 - 349 mm	M/K	ZSI.650B11N IG/G	-	
	OPO-Nr.	Nennlänge	Korpusbreite*	Systemhöhe	Werks-Nr.	Werks-Nr.
	53.918.75	450 mm	350 - 449 mm	M/K	ZSI.450K12N IG/G	-
	53.918.76	500 mm	350 - 449 mm	M/K	ZSI.500K12N IG/G	-
	53.918.77	550 mm	350 - 449 mm	M/K	ZSI.550K12N IG/G	-
	53.918.78	600 mm	350 - 449 mm	M/K	ZSI.600K12N IG/G	-
53.918.79	650 mm	350 - 449 mm	M/K	ZSI.650K12N IG/G	-	
	OPO-Nr.	Nennlänge	Korpusbreite	Systemhöhe	Werks-Nr.	Werks-Nr.
	53.918.85	450 mm	450 - 600 mm	M/K	ZSI.450M13 IG/G	-
	53.918.86	500 mm	450 - 600 mm	M/K	ZSI.500M13 IG/G	-
	53.918.87	550 mm	450 - 600 mm	M/K	ZSI.550M13 IG/G	-
	53.918.88	600 mm	450 - 600 mm	M/K	ZSI.600M13 IG/G	-
53.918.89	650 mm	450 - 600 mm	M/K	ZSI.650M13 IG/G	-	
	OPO-Nr.	Nennlänge	Korpusbreite	Systemhöhe	Werks-Nr.	Werks-Nr.
	53.918.95	450 mm	601 - 649 mm	M/K	ZSI.450B11N IG/G	+ ZSI.450M13 IG/G
	53.918.96	500 mm	601 - 649 mm	M/K	ZSI.500B11N IG/G	+ ZSI.500M13 IG/G
	53.918.97	550 mm	601 - 649 mm	M/K	ZSI.550B11N IG/G	+ ZSI.550M13 IG/G
	53.918.98	600 mm	601 - 649 mm	M/K	ZSI.600B11N IG/G	+ ZSI.600M13 IG/G
53.918.99	650 mm	601 - 649 mm	M/K	ZSI.650B11N IG/G	+ ZSI.650M13 IG/G	
	OPO-Nr.	Nennlänge	Korpusbreite*	Systemhöhe	Werks-Nr.	Werks-Nr.
	53.919.05	450 mm	650 - 750 mm	M/K	ZSI.450K12N IG/G	+ ZSI.450M13 IG/G
	53.919.06	500 mm	650 - 750 mm	M/K	ZSI.500K12N IG/G	+ ZSI.500M13 IG/G
	53.919.07	550 mm	650 - 750 mm	M/K	ZSI.550K12N IG/G	+ ZSI.550M13 IG/G
	53.919.08	600 mm	650 - 750 mm	M/K	ZSI.600K12N IG/G	+ ZSI.600M13 IG/G
53.919.09	650 mm	650 - 750 mm	M/K	ZSI.650K12N IG/G	+ ZSI.650M13 IG/G	
	OPO-Nr.	Nennlänge	Korpusbreite*	Systemhöhe	Werks-Nr.	Werks-Nr.
	53.919.15	450 mm	751 - 899 mm	M/K	ZSI.450K13N IG/G	+ ZSI.450B13N IG/G
	53.919.16	500 mm	751 - 899 mm	M/K	ZSI.500K13N IG/G	+ ZSI.500B12N IG/G
	53.919.17	550 mm	751 - 899 mm	M/K	ZSI.550K13N IG/G	+ ZSI.550B12N IG/G
	53.919.18	600 mm	751 - 899 mm	M/K	ZSI.600K13N IG/G	+ ZSI.600B12N IG/G
53.919.19	650 mm	751 - 899 mm	M/K	ZSI.650K13N IG/G	+ ZSI.650B12N IG/G	
	OPO-Nr.	Nennlänge	Korpusbreite*	Systemhöhe	Werks-Nr.	Werks-Nr.
	53.919.25	450 mm	900 - 1200 mm	M/K	ZSI.450K13N IG/G	+ ZSI.450K14N IG/G
	53.919.26	500 mm	900 - 1200 mm	M/K	ZSI.500K13N IG/G	+ ZSI.500K14 IG/G
	53.919.27	550 mm	900 - 1200 mm	M/K	ZSI.550K13N IG/G	+ ZSI.550K14 IG/G
	53.919.28	600 mm	900 - 1200 mm	M/K	ZSI.600K13N IG/G	+ ZSI.600K14 IG/G
53.919.29	650 mm	900 - 1200 mm	M/K	ZSI.650K13N IG/G	+ ZSI.650K14 IG/G	

* Fach 1: Alu- oder Frischhaltefolienhalter einsetzbar

Fach 2: Messerhalter oder Alu- und Frischhaltefolienhalter in Kombination einsetzbar siehe Seite 32

Schubkasten Innenorganisation ORGA-LINE Edelstahl-Design



Einzel-Set BLUM ORGA-LINE TANDEMBOX antaro für Schubkasten

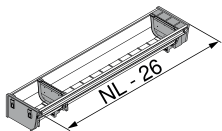

Besteckeneinsatz BLUM ORGA-LINE 103 mm Breite

OPO-Nr.	Nennlänge	B/H/T	Systemhöhe	Werks-Nr.
53.910.01	450 mm	103/64/424 mm	M/K	ZSI.450B11N
53.910.02	500 mm	103/64/474 mm	M/K	ZSI.500B11N
53.910.03	550 mm	103/64/524 mm	M/K	ZSI.550B11N
53.910.04	600 mm	103/64/574 mm	M/K	ZSI.600B11N
53.910.05	650 mm	103/64/624 mm	M/K	ZSI.650B11N

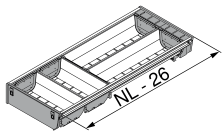

Schalen-Set BLUM ORGA-LINE 192 mm Breite

OPO-Nr.	Nennlänge	B/H/T	Systemhöhe	Werks-Nr.
53.910.11	450 mm	192/64/424 mm	M/K	ZSI.450B12N
53.910.12	500 mm	192/64/474 mm	M/K	ZSI.500B12N
53.910.13	550 mm	192/64/524 mm	M/K	ZSI.550B12N
53.910.14	600 mm	192/64/574 mm	M/K	ZSI.600B12N
53.910.15	650 mm	192/64/624 mm	M/K	ZSI.650B12N

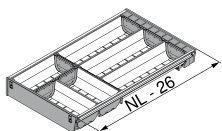

Schalen-Set BLUM ORGA-LINE 280 mm Breite

OPO-Nr.	Nennlänge	B/H/T	Systemhöhe	Werks-Nr.
53.910.21	450 mm	280/64/424 mm	M/K	ZSI.450B13N
53.910.22	500 mm	280/64/474 mm	M/K	ZSI.500B13
53.910.23	550 mm	280/64/524 mm	M/K	ZSI.550B13
53.910.24	600 mm	280/64/574 mm	M/K	ZSI.600B13
53.910.25	650 mm	280/64/624 mm	M/K	ZSI.650B13

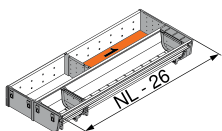

Kombi-Set für TANDEMBOX antaro BLUM ORGA-LINE 200* mm Breite

OPO-Nr.	Nennlänge	B/H/T	Systemhöhe	Werks-Nr.
53.910.81	450 mm	200/64/424 mm	M/K	ZSI.450K12N
53.910.82	500 mm	200/64/474 mm	M/K	ZSI.500K12N
53.910.83	550 mm	200/64/524 mm	M/K	ZSI.550K12N
53.910.84	600 mm	200/64/574 mm	M/K	ZSI.600K12N
53.910.85	650 mm	200/64/624 mm	M/K	ZSI.650K12N

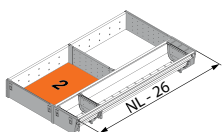

Facheinteilung-Set für TANDEMBOX antaro BLUM ORGA-LINE 289* mm Breite

OPO-Nr.	Nennlänge	B/H/T	Systemhöhe	Werks-Nr.
53.910.91	450 mm	289/64/424 mm	M/K	ZSI.450K13N
53.910.92	500 mm	289/64/474 mm	M/K	ZSI.500K13N
53.910.93	550 mm	289/64/524 mm	M/K	ZSI.550K13N
53.910.94	600 mm	289/64/574 mm	M/K	ZSI.600K13N
53.910.95	650 mm	289/64/624 mm	M/K	ZSI.650K13N

* Fach 1: Alu- oder Frischhaltefolienhalter einsetzbar

Fach 2: Messerhalter oder Alu- und Frischhaltefolienhalter in Kombination einsetzbar siehe Seite 32

Schubkasten Innenorganisation ORGA-LINE Edelstahl-Design für TANDEMBOX antaro

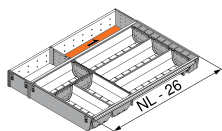

Facheinteilung-Set für TANDEMBOX antaro BLUM ORGA-LINE 377* mm Breite

OPO-Nr.	Nennlänge	B/H/T	Systemhöhe	Werks-Nr.
53.910.51	450 mm	377/64/424 mm	M/K	ZSI.450KI4N
53.910.52	500 mm	377/64/474 mm	M/K	ZSI.500KI4
53.910.53	550 mm	377/64/524 mm	M/K	ZSI.550KI4
53.910.54	600 mm	377/64/574 mm	M/K	ZSI.600KI4
53.910.55	650 mm	377/64/624 mm	M/K	ZSI.650KI4

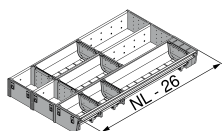

Facheinteilung-Set für TANDEMBOX antaro BLUM ORGA-LINE 297 mm Breite

OPO-Nr.	Nennlänge	B/H/T	Systemhöhe	Werks-Nr.
53.911.31	450 mm	297/64/424 mm	M/K	ZSI.450MI3
53.911.32	500 mm	297/64/474 mm	M/K	ZSI.500MI3
53.911.33	550 mm	297/64/524 mm	M/K	ZSI.550MI3
53.911.34	600 mm	297/64/574 mm	M/K	ZSI.600MI3
53.911.35	650 mm	297/64/624 mm	M/K	ZSI.650MI3

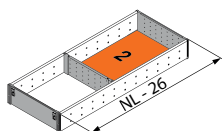

Facheinteilung-Set für TANDEMBOX antaro BLUM ORGA-LINE 194* mm Breite

OPO-Nr.	Nennlänge	B/H/T	Systemhöhe	Werks-Nr.
53.910.61	450 mm	194/64/424 mm	M/K	ZSI.450FI2N
53.910.62	500 mm	194/64/474 mm	M/K	ZSI.500FI2N
53.910.63	550 mm	194/64/524 mm	M/K	ZSI.550FI2N
53.910.64	600 mm	194/64/574 mm	M/K	ZSI.600FI2N
53.910.65	650 mm	194/64/624 mm	M/K	ZSI.650FI2N

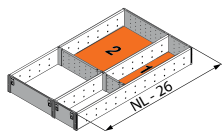

Facheinteilung-Set für TANDEMBOX antaro BLUM ORGA-LINE 291* mm Breite

OPO-Nr.	Nennlänge	B/H/T	Systemhöhe	Werks-Nr.
53.911.11	450 mm	291/64/424 mm	M/K	ZSI.450FI3
53.911.12	500 mm	291/64/474 mm	M/K	ZSI.500FI3
53.911.13	550 mm	291/64/524 mm	M/K	ZSI.550FI3
53.911.14	600 mm	291/64/574 mm	M/K	ZSI.600FI3
53.911.15	650 mm	291/64/624 mm	M/K	ZSI.650FI3

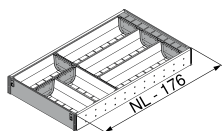

Besteckeneinsatz für TANDEMBOX antaro BLUM ORGA-LINE 282 mm Breite

OPO-Nr.	Nennlänge	B/H/T	Systemhöhe	Werks-Nr.
53.911.41	450 mm	282/64/424 mm	M/K	ZSI.450BI3E
53.911.42	500 mm	282/64/474 mm	M/K	ZSI.500BI3E

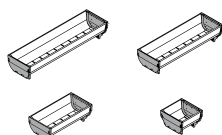

Schale für TANDEMBOX antaro BLUM ORGA-LINE 88 mm Breite

OPO-Nr.	Nennlänge	B/H/T	Systemhöhe	Werks-Nr.
53.911.51	450 - 650 mm	88/64/88 mm	M/K	ZSI.010SI
53.911.52	450 - 650 mm	88/64/176 mm	M/K	ZSI.020SI
53.911.53	450 - 650 mm	88/64/264 mm	M/K	ZSI.030SI
53.911.54	450 - 650 mm	88/64/352 mm	M/K	ZSI.040SI

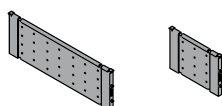

Querteiler für TANDEMBOX antaro BLUM ORGA-LINE

OPO-Nr.	Nennlänge	B/H	Systemhöhe	Werks-Nr.
53.911.61	450 - 650 mm	88/64 mm	M/K	ZSI.010Q
53.911.62	450 - 650 mm	176/64 mm	M/K	ZSI.020Q

* Fach 1: Alu- oder Frischhaltefolienhalter einsetzbar
 Fach 2: Messerhalter oder Alu- und Frischhaltefolienhalter in Kombination einsetzbar siehe Seite 32

Antirutschmatten BLUM TANDEMBOX antaro, Fixzuschnitt für Korpusseitenstärke 16 mm

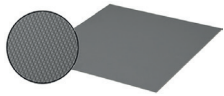

Farbe	anthrazit				
	Nennlänge	Nennlänge	Nennlänge	Nennlänge	Nennlänge
Korpusbreite	400 mm	450 mm	500 mm	550 mm	650 mm
275 mm	-	-	53.201.50	-	53.201.70
300 mm	-	-	53.201.51	-	53.201.71
350 mm	-	-	-	-	-
400 mm	-	-	53.201.52	-	-
450 mm	-	-	53.201.53	-	-
500 mm	-	53.201.41	53.201.54	53.201.80	-
550 mm	-	53.201.42	53.201.55	53.201.81	53.201.72
600 mm	53.201.40	53.201.43	53.201.56	53.201.82	53.201.73
800 mm	-	-	53.201.57	-	-
900 mm	-	-	53.201.58	53.201.83	53.201.74
1000 mm	-	-	53.201.59	-	-
1100 mm	-	-	53.201.60	-	-
1200 mm	-	-	53.201.61	53.201.84	53.201.75

Herdschubkasten-Besteckeinsatz MONO N, NL 500 mm



	Kunststoff, Breite 326 mm		
Korpusbreite	seidenweiss	oriongrau	terraschwarz
500-1200 mm	53.042.55	-	53.042.57

Gewürzdoseneinsätze PEKA, Nennlänge 450/500/550 mm

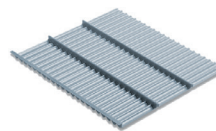

	Kunststoff, Breite 1300 mm		
	Farbe	Systemhöhe	OPO-Nr.
	weiss	M/K	53.066.15
	silber	M/K	53.066.14
	anthrazit	M/K	53.066.16

Besteckeneinsatz MONO M / K, Nennlänge 500 mm



	Kunststoff, Breite 326 mm		
Korpusbreite	seidenweiss	oriongrau	terraschwarz
500-1200 mm	53.042.50	53.042.51	53.042.52

Besteckeneinsatz NINKA Cuisio Universal, Nennlänge 500 mm



	Kunststoff	
Korpusbreite	weiss/alu	
450 mm	53.003.40	
600 mm	53.003.41	

Folienhalter BLUM ORGA-LINE für Fachgrösse 1 (2*)

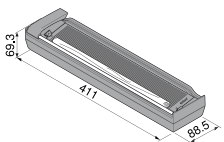

	für Frischhaltefolie, NL 450 - 650 mm	
Systemhöhe	staubgrau	Werks-Nr.
M/K	53.911.65	ZSZ.01F0

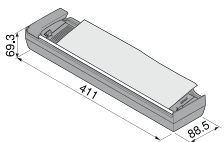

	für Alufolie, NL 450 - 650 mm	
Systemhöhe	staubgrau	Werks-Nr.
M/K	53.911.66	ZSZ.02F0

* Die beiden Folienhalter können in Kombination auch in die Fachgrösse 2 eingesetzt werden.

Messerhalter BLUM ORGA-LINE für Fachgrösse 2

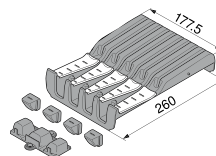

	Kunststoff, NL 450 - 650 mm	
Systemhöhe	staubgrau	Werks-Nr.
M/K	53.911.67	ZSZ.02M0

Tellerhalter BLUM für Frontschubkasten



	Kunststoff	
Systemhöhe	staubgrau	Werks-Nr.
C/D	53.902.47	ZC7T0350

Gewürzhalter BLUM ORGA-LINE für Frontschubkasten

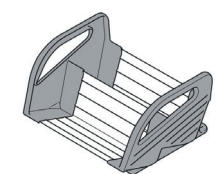

	Kunststoff		
Systemhöhe	staubgrau	Korpusbreite	Werks-Nr.
C/D	53.912.81	300 mm	ZFZ.30G0I
C/D	53.912.82	350 mm	ZFZ.40G0I
C/D	53.912.83	400 mm	ZFZ.45G0I



Korpusschiene MOVENTO S mit BLUMOTION

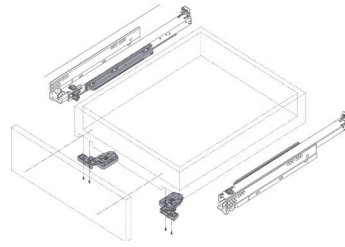

Lieferumfang:
Vollauszug links/rechts

BLUMOTION
by Blum

Vollauszug MOVENTO S mit BLUMOTION 760H / 766H (schaltbar)

Multipack L/R	Packung	1/6		
Nennlänge	40 kg	Werks-Nr.	60 kg	Werks-Nr.
250 mm	51.168.81	760H2500S	-	-
270 mm	51.168.82	760H2700S	-	-
300 mm	51.168.83	760H3000S	-	-
320 mm	51.168.84	760H3200S	-	-
350 mm	51.168.85	760H3500S	-	-
380 mm	51.168.86	760H3800S	-	-
400 mm	51.168.87	760H4000S	-	-
420 mm	51.168.88	760H4200S	-	-
450 mm	51.168.89	760H4500S	51.168.71	766H4500S
480 mm	51.168.90	760H4800S	-	-
500 mm	51.168.91	760H5000S	51.168.72	766H5000S
520 mm	51.168.92	760H5200S	51.168.73	766H5200S
550 mm	51.168.93	760H5500S	51.168.74	766H5500S
580 mm	-	-	51.168.75	766H5800S
600 mm	51.168.94	760H6000S	51.168.76	766H6000S
650 mm	-	-	51.168.77	766H6500S
700 mm	-	-	51.168.78	766H7000S
750 mm	-	-	51.168.79	766H7500S

Schubkastenlänge = Nennlänge - 10 mm / Lichte Schubkastenbreite = Lichte Korpusweite - 42 mm

Kupplung BLUM MOVENTO 760H/766H



OPO-Nr.	Ausführung	Packung	Werks-Nr.
51.169.33	links/rechts	1	T51.7601
51.169.30	links	100	T51.7601
51.169.31	rechts	100	T51.7601
51.169.32	Tiefenverstellung	1	298.7600

Seitenstabilisierung BLUM MOVENTO zum Ablängen



passend bis Korpusbreite 1400 mm
Zuschnitt: Lichte Korpusweite - 315 mm

Nennlänge	OPO-Nr.	Werks-Nr.
250 - 400 mm	51.169.35	ZS7M400MU
420 - 600 mm	51.169.36	ZS7M600MU
650 - 750 mm	51.169.37	ZS7M750MU

Komplett-Schubkasten in Massivholz, massindividuell gefertigt



OPO-Nr.	Ausführung	Holzart
51.354.20*	auf Mass	nach Wahl

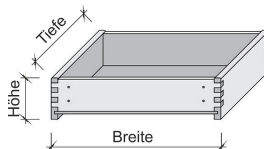

* Zur einfachen Bestellung bitte den Onlinekonfigurator verwenden

Führungen für Holzschubkasten MOVENTO S / TIP-ON BLUMOTION



Korpusschiene MOVENTO S mit TIP-ON BLUMOTION

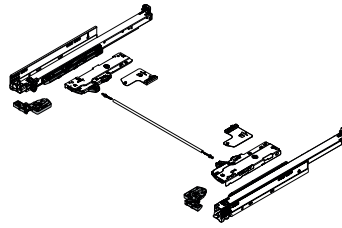

Lieferumfang:
• Vollauszug links/rechts



Vollauszug MOVENTO S mit TIP-ON BLUMOTION 760H/766H (schaltbar)

Multipack L/R	Packung	1/6		60 kg	
Nennlänge	40 kg	Werks-Nr.		Werks-Nr.	
250 mm	51.168.81*	760H2500S	-	-	-
270 mm	51.168.82	760H2700S	-	-	-
300 mm	51.168.83	760H3000S	-	-	-
320 mm	51.168.84	760H3200S	-	-	-
350 mm	51.168.85	760H3500S	-	-	-
380 mm	51.168.86	760H3800S	-	-	-
400 mm	51.168.87	760H4000S	-	-	-
420 mm	51.168.88	760H4200S	-	-	-
450 mm	51.168.89	760H4500S	51.168.71	766H4500S	-
480 mm	51.168.90	760H4800S	-	-	-
500 mm	51.168.91	760H5000S	51.168.72	766H5000S	-
520 mm	51.168.92	760H5200S	51.168.73	766H5200S	-
550 mm	51.168.93	760H5500S	51.168.74	766H5500S	-
580 mm	-	-	51.168.75	766H5800S	-
600 mm	51.168.94	760H6000S	51.168.76	766H6000S	-
650 mm	-	-	51.168.77	766H6500S	-
700 mm	-	-	51.168.78	766H7000S	-
750 mm	-	-	51.168.79	766H7500S	-

Schubkastenlänge = Nennlänge -10 mm / Lichte Schubkastenbreite = Lichte Korpusweite -42 mm – *nicht mit TIP-ON kombinierbar

Kupplung BLUM MOVENTO 760H/766H



OPO-Nr.	Ausführung	Packung	Werks-Nr.
51.169.33	links/rechts	1	T51.7601
51.169.30	links	100	T51.7601
51.169.31	rechts	100	T51.7601

Seitenstabilisierung BLUM MOVENTO zum Ablängen



passend bis Korpusbreite 1400 mm
Zuschnitt: Lichte Korpusweite -315 mm

Nennlänge	OPO-Nr.	Werks-Nr.
250 - 400 mm	51.169.35	ZS7M400MU
420 - 600 mm	51.169.36	ZS7M600MU
650 - 750 mm	51.169.37	ZS7M750MU

Einheit-Mitnehmer TIP-ON BLUMOTION



Lieferumfang:
• Einheit und Mitnehmer
• 2 Stück Synchro-Adapter

Typ	Nennlänge	OPO-Nr.	Werks-Nr.
S0/ 0 - 10 kg	270 - 320 mm	53.892.20*	T60L7040
S1/10 - 20 kg	270 - 320 mm	53.892.21*	T60L7140
L1/ 0 - 20 kg	350 - 600 mm	53.892.22*	T60L7340
L3/15 - 40 kg	350 - 600 mm	53.892.23*	T60L7540
L5/25 - 60 kg	350 - 750 mm	53.892.24**	T60L7570

* nur für 40 kg Vollauszug, ** nur für 60 kg Vollauszug

Synchro-Welle TIP-ON BLUMOTION



Lieferumfang:
• 1 Stück

Korpusbreite	Lichte Weite (LW)	OPO-Nr.	Werks-Nr.
275 - 300 mm	265 - 313 mm	53.890.71*	T60.3000
300 - 1400 mm	314 - 1392 mm	51.170.06**	T60.1125W

Zuschnitt: * LW -241 mm, ** LW -267 mm



Korpusschiene MOVENTO TIP-ON

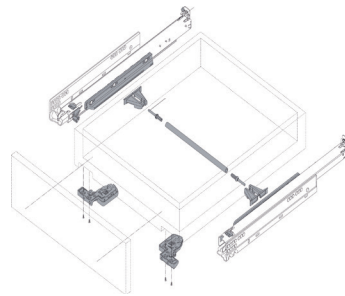

Lieferumfang:
• Vollauszug links/rechts

TIP-ON
by Blum

Vollauszug MOVENTO mit TIP-ON 760H/766H

Multipack L/R	Packung	1/6		
Nennlänge	40 kg	Werks-Nr.	60 kg	Werks-Nr.
250 mm	51.169.41	760H2500T	-	-
270 mm	51.169.42	760H2700T	-	-
300 mm	51.169.43	760H3000T	-	-
320 mm	51.169.44	760H3200T	-	-
350 mm	51.169.45	760H3500T	-	-
380 mm	51.169.46	760H3800T	-	-
400 mm	51.169.47	760H4000T	-	-
420 mm	51.169.48	760H4200T	-	-
450 mm	51.169.49	760H4500T	51.169.60	766H4500T
480 mm	51.169.50	760H4800T	-	-
500 mm	51.169.51	760H5000T	51.169.61	766H5000T
520 mm	51.169.52	760H5200T	51.169.62	766H5200T
550 mm	51.169.53	760H5500T	51.169.63	766H5500T
580 mm	-	-	51.169.64	766H5800T
600 mm	51.169.54	760H6000T	51.169.65	766H6000T
650 mm	-	-	51.169.66	766H6500T
700 mm	-	-	51.169.67	766H7000T
750 mm	-	-	51.169.68	766H7500T

Schubkastenlänge = Nennlänge - 10 mm / Lichte Schubkastenbreite = Lichte Korpusweite - 42 mm

Kupplung BLUM MOVENTO 760H/766H



OPO-Nr.	Ausführung	Packung	Werks-Nr.
51.169.33	links/rechts	1	T51.7601
51.169.30	links	100	T51.7601
51.169.31	rechts	100	T51.7601

Seitenstabilisierung BLUM MOVENTO zum Ablängen



passend bis Korpusbreite 1400 mm
Zuschnitt: Lichte Korpusweite - 315 mm

Nennlänge	OPO-Nr.	Werks-Nr.
250 - 400 mm	51.169.35	ZS7M400MU
420 - 600 mm	51.169.36	ZS7M600MU
650 - 750 mm	51.169.37	ZS7M750MU

Einheit-Mitnehmer TIP-ON für MOVENTO

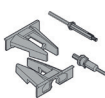

Lieferumfang:
• 1 x Kupplung
• 1 x Überlastkupplung
• 2 x Aufnahme (ohne Welle)

OPO-Nr.	Ausführung	Werks-Nr.
51.169.69	links/rechts	T57.7400.01

Synchro-Welle TIP-ON



Lieferumfang:
• 1 Stück

Korpusbreite	Lichte Weite (LW)	OPO-Nr.	Werks-Nr.
275 - 300 mm	245 - 293 mm	53.890.71*	T60.3000
300 - 1400 mm	294 - 1370 mm	51.170.06**	T60.1125W

Zuschnitt: * LW -223 mm, ** LW -249 mm

Elektromechanische Öffnungsunterstützung SERVO-DRIVE

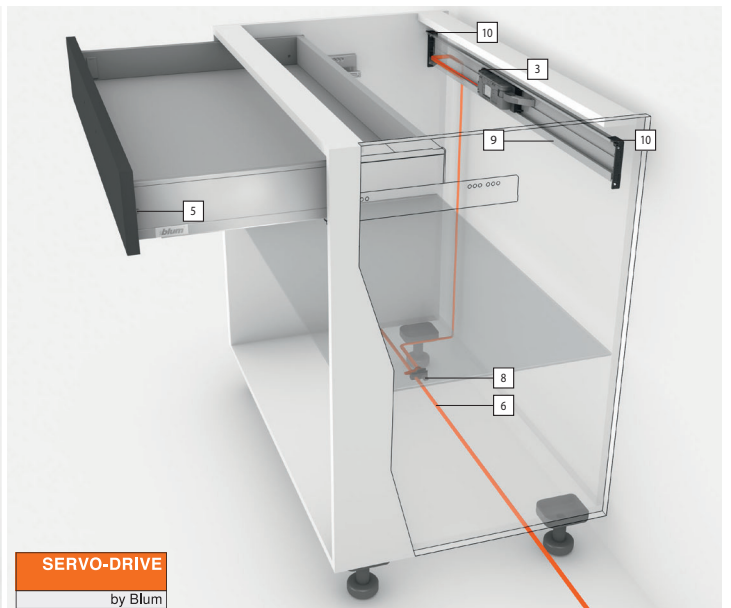
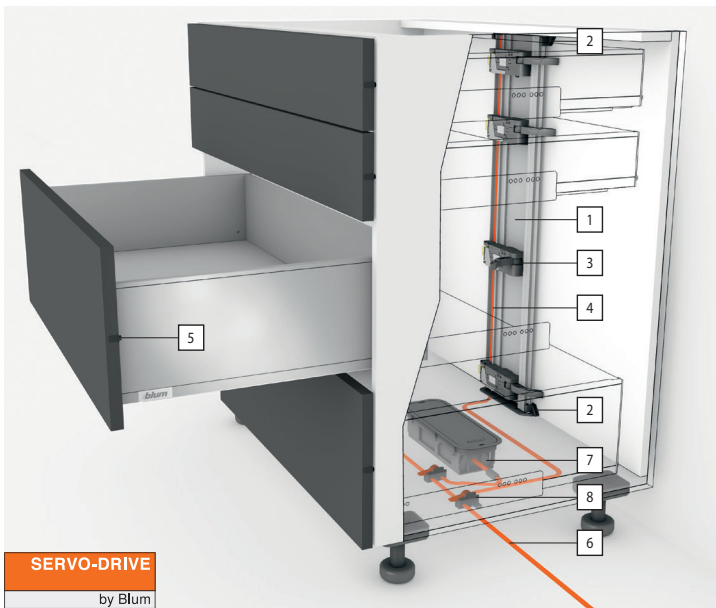

SERVO-DRIVE Lösungen horizontal/vertikal für TANDEMBOX antaro/MOVENTO



Trägerprofil - vertikal			
Nr.	Länge	OPO-Nr	Werks-Nr.
1	710 mm	53.915.04	Z10T710AA21
1	1170 mm	53.915.05	Z10T1170A

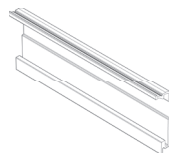

Trägerprofil - horizontal, Länge 1143 mm			
Nr.	Profil	OPO-Nr	Werks-Nr.
9	horizontal	53.915.47	Z10T1143B

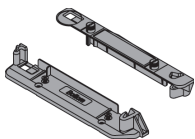

Trägerprofil-Aufnahme - vertikal			
Nr.	Traverse	OPO-Nr	Werks-Nr.
2	liegend	53.915.10	Z10D01E0.01
2	stehend	53.915.11	Z10D01EA.01

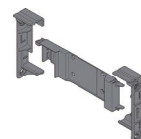

Aufnahme für Trägerprofil - horizontal			
Nr.	Profil	OPO-Nr	Werks-Nr.
10	horizontal	53.915.48	Z10D5210

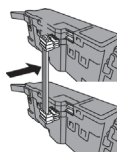

Synchronisationskabel			
Nr.	Länge	OPO-Nr	Werks-Nr.
4	1200 mm	53.915.36	Z10K120S
4	80 mm	53.915.38	Z10K008S

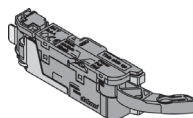

Antriebseinheit - für COMBOX geeignet			
Nr.	Ausführung	OPO-Nr	Werks-Nr.
3	1-fach	53.915.15	Z10A3000.03

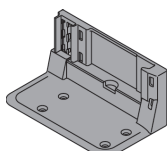

Aufnahmewinkel unten - für 1 oder 2 Antriebseinheit, mit Kabel			
Nr.	Ausführung	OPO-Nr	Werks-Nr.
-	1-fach	53.915.45	Z10D0311
-	2-fach	53.915.46	Z10D7201.01

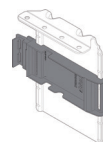

Aufnahmewinkel oben			
Nr.	Ausführung	OPO-Nr	Werks-Nr.
-	1-fach	53.915.49	Z10D6252



SERVO-DRIVE flex Antriebseinheit für Kühl- und Gefrierschränke sowie Geschirrspüler

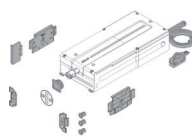

Antriebseinheit - flex für Kühl-, Gefrier- und Geschirrspüler

Nr.	Ausführung	OPO-Nr	Werks-Nr.
12	links/rechts	53.915.50	Z10C500A

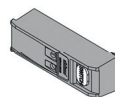

Funkempfänger - flex für Kühl-, Gefrier- und Geschirrspüler, Höhe 1780 mm

Nr.	L/B/H	OPO-Nr	Werks-Nr.
-	82/28/22 mm	53.915.52	Z10C5007



Funk-Schalter

Nr.	Ausführung	OPO-Nr	Werks-Nr.
-	links/rechts	53.915.51	Z1P5020

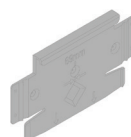

Montageplatte für Geschirrspüler

Nr.	Ausführung	OPO-Nr	Werks-Nr.
-	links/rechts	53.915.53	Z10C5005

Netzteile SERVO-DRIVE für Single- oder Mehrfachlösungen TANDEMBOX antaro/MOVENTO/AVENTOS



Steckernetzteil - 12 V, Euro-Stecker

Nr.	Ausführung	OPO-Nr	Werks-Nr.
11	Single-Lösung	53.915.26	993.0830.01

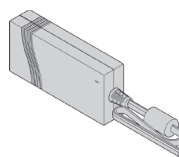

Netzgerät - 24 V, 1-16 SERVO-DRIVE Einheiten

Nr.	Ausführung	OPO-Nr	Werks-Nr.
-	Mehrfach-Lösung	53.915.25	Z10NE020A

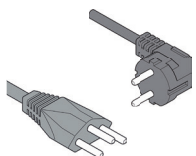

Netzkabel - 230 V, Länge 2000 mm

Nr.	Ausführung	OPO-Nr	Werks-Nr.
-	T12 3-polig (CH)	53.915.30	Z10M200E
-	Schuko-Stecker (DE)	53.915.31	Z10M200E



Elektro - Verteilerkabel, 5x Kabelendschutz

Nr.	Länge	OPO-Nr	Werks-Nr.
6	8000 mm	53.915.21	Z10K800AE



Verbindungsknoten, 2x Kabelendschutz

Nr.	OPO-Nr	Werks-Nr.
8	53.915.22	Z10V100E.01

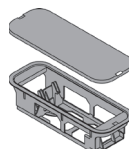

Netzgeräthalterung

Nr.	Montage	OPO-Nr	Werks-Nr.
7	Boden	53.915.32	Z10NG000
-	Wand	53.915.33	Z10NG120

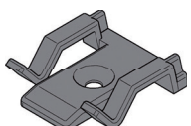

Kabelhalter für Verteilerkabel

Nr.	OPO-Nr	Werks-Nr.
-	53.915.39	Z10K009

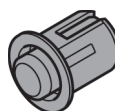

Blum-Distanzpuffer, Höhe 2.6 mm

Nr.	Bohrø	OPO-Nr	Werks-Nr.
5	8 mm	53.915.40	993.0830.01
5	5 mm	53.915.41	993.053

Auszug Hochschwenkbeschläge AVENTOS

Das komplette AVENTOS Zubehör finden Sie auf dem OPO-Net® unter der Kraftspeichereinheit der gewünschten Klappenanwendung übersichtlich aufgeführt.

Hochfaltklappe AVENTOS HF, Öffnungswinkel 120°



Leistungsfaktor	Oberfläche	BLUMOTION	Werks-Nr.
2600 - 5500	verzinkt	53.508.01	20F2200.05
5350 - 10150	verzinkt	53.508.02	20F2500.05
9000 - 17250	verzinkt	53.508.03	20F2800.05
SERVO-DRIVE-Set (Zubehör siehe Seite 37)		50.597.21	21FA000

Teleskophebel-Set BLUM für Hochfaltklappe AVENTOS HF/SERVO-DRIVE

Korpshöhe	Oberfläche	BLUMOTION	Werks-Nr.
480-570 mm	vernickelt	53.508.10	20F3200.01
560-710 mm	vernickelt	53.508.11	20F3500.01
700-900 mm	vernickelt	53.508.12	20F3800.01
760-1040 mm	vernickelt	53.508.13	20F3900.01

Abdeckkappen-Set BLUM für Hochfaltklappe AVENTOS HF

Ausführung	seidenweiss	hellgrau	tiefgrau	Werks-Nr.
BLUMOTION	53.508.21	53.508.22	53.508.20	20F8000
SERVO-DRIVE	53.508.26	53.508.25	53.508.27	21F8000



SERVO-DRIVE
by Blum

Hochschwenklappe AVENTOS HS



Korpshöhe	Typ	BLUMOTION	Werks-Nr.	Typ	BLUMOTION	Werks-Nr.	Typ	BLUMOTION	Werks-Nr.
350 - 525 mm	A	53.509.01	20S2A00.05	B	53.509.02	20S2B00.05	C	53.509.03	20S2C00.05
526 - 675 mm	D	53.509.04	20S2D00.05	E	53.509.05	20S2E00.05	F	53.509.06	20S2F00.05
676 - 800 mm	G	53.509.07	20S2G00.05	H	53.509.08	20S2H00.05	I	53.509.09	20S2I00.05
SERVO-DRIVE-Set (Zubehör siehe Seite 37)								50.597.21	21FA000

Hebelpaket-Set BLUM für Hochschwenklappe AVENTOS HS

Ausführung	Korpshöhe	Oberfläche	OPO-Nr.	Werks-Nr.
BLUMOTION	350 - 800 mm	vernickelt	53.509.10	20S3500.06
SERVO-DRIVE	350 - 800 mm	vernickelt	53.509.11	21S3500.01

Querstabilisierungsstange (53.809.28) siehe Seite 39

Abdeckkappen-Set BLUM für Hochschwenklappe AVENTOS HS

Ausführung	seidenweiss	hellgrau	tiefgrau	Werks-Nr.
BLUMOTION	53.509.17	53.509.16	53.509.15	20S8000
SERVO-DRIVE	53.509.14	53.509.13	53.509.12	21S8000



SERVO-DRIVE
by Blum

Hochliftklappe AVENTOS HL



Korpshöhe	Klappengewicht	BLUMOTION	Werks-Nr.
300 - 399 mm	1.25 - 4.25 kg	53.510.01	20L2100.05
300 - 550 mm	1.75 - 7.25 kg	53.510.02	20L2300.05
300 - 580 mm	2.00 - 12.00 kg	53.510.03	20L2500.05
300 - 580 mm	4.25 - 20.00 kg	53.510.04	20L2700.05
350 - 580 mm	8.25 - 20.00 kg	53.510.05	20L2900.05
SERVO-DRIVE-Set (Zubehör siehe Seite 37)		50.597.21	21FA000

Teleskophebel-Set BLUM für Hochliftklappe AVENTOS HL/SERVO-DRIVE

Korpshöhe	Oberfläche	BLUMOTION	Werks-Nr.	SERVO-DRIVE	Werks-Nr.
300 - 349 mm	vernickelt	53.510.10	20L3200.06	53.510.30	21L3200.01
350 - 399 mm	vernickelt	53.510.11	20L3500.06	53.510.31	21L3500.01
400 - 550 mm	vernickelt	53.510.12	20L3800.06	53.510.32	21L3800.01
450 - 580 mm	vernickelt	53.510.13	20L3900.06	53.510.33	21L3900.01

Querstabilisierungsstange (53.510.26) siehe Seite 39



SERVO-DRIVE
by Blum

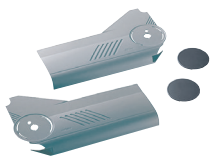

Abdeckkappen-Set BLUM für Hochliftklappe AVENTOS HL

Ausführung	seidenweiss	hellgrau	tiefgrau	Werks-Nr.
BLUMOTION	53.510.23	53.510.22	53.510.21	20L8000.01
SERVO-DRIVE	53.510.36	53.510.37	53.510.35	21L8000



Querstabilisierungsstange BLUM für Hochschwenklappe AVENTOS HS + HL SERVO-DRIVE

Korpusbreite	Länge	Typ	OPO-Nr.	Werks-Nr.
< 1200 mm	1061 mm	HS	53.509.28	20Q1061UN
< 1200 mm	1061 mm	HL	53.510.26	20Q1061UA



Verbindungsstück-Set BLUM für Querstabilisierungsstange AVENTOS HS + HL SERVO-DRIVE

Korpusbreite	Ø	Typ	OPO-Nr.	Werks-Nr.
> 1200 mm	16 mm	HS	53.509.29	20Q153ZN
> 1200 mm	oval	HL	53.510.25	20Q153ZA

Hochklappe AVENTOS HK top Öffnungswinkel 107 °

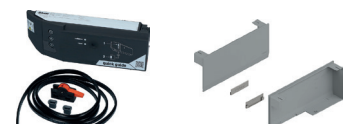

SERVO-DRIVE
by Blum

TIP-ON siehe Seite 43

Montage	Leistungsfaktor	BLUMOTION	Werks-Nr.	Leistungsfaktor	TIP-ON	Werks-Nr.
Spanplattenschrauben	420–1610	50.599.11	22K2300	420–1610	50.599.15	22K2300T
Spanplattenschrauben	930–2800	50.599.12	22K2500	930–2800	50.599.16	22K2500T
Spanplattenschrauben	1730–5200	50.599.13	22K2700	1730–5200	50.599.17	22K2700T
Spanplattenschrauben	3200–9000	50.599.14	22K2900	3200–9000	50.599.18	22K2900T
Systemschrauben	420–1610	50.599.01	22K2310	420–1610	50.599.05	22K2310T
Systemschrauben	930–2800	50.599.02	22K2510	930–2800	50.599.06	22K2510T
Systemschrauben	1730–5200	50.599.03	22K2710	1730–5200	50.599.07	22K2710T
Systemschrauben	3200–9000	50.599.04	22K2910	3200–9000	50.599.08	22K2910T
SERVO-DRIVE-Set (Zubehör siehe Seite 37)		50.599.25	23KA000			

Abdeckkappen-Set für Hochklappe AVENTOS HK top / TIP-ON

Ausführung	seidenweiss	hellgrau	tiefgrau	Werks-Nr.
BLUMOTION/TIP-ON	50.599.20	50.599.21	50.599.22	22K8000
SERVO-DRIVE	50.599.31	50.599.32	50.599.33	23K8000

Hochklappe AVENTOS HK-S Öffnungswinkel 107 °



TIP-ON
by Blum

TIP-ON siehe Seite 43

Farbe	Leistungsfaktor	BLUMOTION	Werks-Nr.	Leistungsfaktor	TIP-ON	Werks-Nr.
seidenweiss	220 - 500	50.599.40	20K2B00.06	220 - 500	50.599.60	20K2B00T06
seidenweiss	400 - 1000	50.599.41	20K2C00.06	400 - 1000	50.599.61	20K2C00T06
seidenweiss	960 - 2215	50.599.42	20K2E00.06	960 - 2215	50.599.62	20K2E00T06
hellgrau	220 - 500	50.599.45	20K2B00.06	220 - 500	50.599.65	20K2B00T06
hellgrau	400 - 1000	50.599.46	20K2C00.06	400 - 1000	50.599.66	20K2C00T06
hellgrau	960 - 2215	50.599.47	20K2E00.06	960 - 2215	50.599.67	20K2E00T06
tiefgrau	220 - 500	50.599.50	20K2B00.06	220 - 500	50.599.70	20K2B00T06
tiefgrau	400 - 1000	50.599.51	20K2C00.06	400 - 1000	50.599.71	20K2C00T06
tiefgrau	960 - 2215	50.599.52	20K2E00.06	960 - 2215	50.599.72	20K2E00T06

Klappenstütze AVENTOS HK-XS, Öffnungswinkel 105 °, vernickelt



TIP-ON
by Blum

TIP-ON siehe Seite 43

Leistungsfaktor	BLUMOTION	Werks-Nr.	Leistungsfaktor	TIP-ON	Werks-Nr.
200 - 1000	50.598.01	20K1101	180 - 800	50.598.11	20K1101T
500 - 1500	50.598.02	20K1301	500 - 1200	50.598.12	20K1301T
800 - 1800	50.598.03	20K1501	800 - 1600	50.598.13	20K1501T

Anbindungen AVENTOX HK-XS, Stahl vernickelt

Montage	EXPANDO	Werks-Nr.	zum Anschauen	Werks-Nr.
Korpusbefestigung	50.598.23	20K51E1	50.598.24	20K5101
Frontbefestigung	50.598.20	20K41E1	50.598.21	20K4101

Auszug Scharnierprogramm CLIP TOP/CLIP TOP BLUMOTION



Topfbänder BLUM CLIP top/CLIP top BLUMOTION, 110 °, mit Feder

Anschlag	Oberfläche	Topf	CLIP TOP	Werks-Nr.	BLUMOTION	Werks-Nr.
Eckband	vernickelt	INSERTA	48.910.02	71T3590	48.910.01	71B3590
Eckband	ONYX schwarz	INSERTA	-	-	48.913.15	71B3590
Eckband	vernickelt	Anschrauben	48.910.05	71T3550	48.910.04	71B3550
Eckband	ONYX schwarz	Anschrauben	-	-	48.913.14	71B3550
Eckband	vernickelt	Einpressen	48.910.08	71T3580	48.910.07	71B3580
Mittelband	vernickelt	INSERTA	48.910.12	71T3690	48.910.11	71B3690
Mittelband	ONYX schwarz	INSERTA	-	-	48.913.17	71B3690
Mittelband	vernickelt	Anschrauben	48.910.15	71T3650	48.910.14	71B3650
Mittelband	ONYX schwarz	Anschrauben	-	-	48.913.16	71B3650
Mittelband	vernickelt	Einpressen	48.910.18	71T3680	48.910.17	71B3680
Innenband	vernickelt	INSERTA	48.910.22	71T3790	48.910.21	71B3790
Innenband	ONYX schwarz	INSERTA	-	-	48.913.19	71B3790
Innenband	vernickelt	Anschrauben	48.910.25	71T3750	48.910.24	71B3750
Innenband	ONYX schwarz	Anschrauben	-	-	48.913.18	71B3750
Innenband	vernickelt	Einpressen	48.910.28	71T3780	48.910.27	71B3780

TIP-ON

by Blum

TIP-ON siehe Seite 43

Topfbänder BLUM CLIP top, 110 °, ohne Feder

Anschlag	Oberfläche	Topf	CLIP TOP	Werks-Nr.	BLUMOTION	Werks-Nr.
Eckband	vernickelt	INSERTA	48.910.03	70T3590.TL	-	-
Eckband	vernickelt	Anschrauben	48.910.06	70T3550.TL	-	-
Mittelband	vernickelt	INSERTA	48.910.13	70T3690.TL	-	-
Mittelband	vernickelt	Anschrauben	48.910.16	70T3650.TL	-	-
Innenband	vernickelt	INSERTA	48.910.23	70T3790.TL	-	-
Innenband	vernickelt	Anschrauben	48.910.26	70T3750.TL	-	-



Dünnür-Topfbänder BLUM CLIP top/CLIP top BLUMOTION, 110 °, mit Feder

Anschlag	Oberfläche	Topf	CLIP TOP	Werks-Nr.	BLUMOTION	Werks-Nr.
Eckband, Mittelband, Innenband	vernickelt	EXPANDO T	48.909.52	71T453T	48.909.50	71B453T
Eckband, Mittelband, Innenband	ONYX schwarz	EXPANDO T	-	-	48.909.51	71B453T

Topfbänder BLUM CLIP top BLUMOTION/CLIP top, 110 ° Spezial, mit Feder für grossen Türaufschlag bei dicken Korpusseiten

Anschlag	Oberfläche	Topf	CLIP TOP	Werks-Nr.	BLUMOTION	Werks-Nr.
Eckband	vernickelt	INSERTA	48.910.32	73T3590	48.910.31	73B3590
Eckband	vernickelt	Anschrauben	-	-	48.910.34	73B3550

TIP-ON

by Blum

TIP-ON siehe Seite 43

Topfbänder BLUM CLIP top, 110 ° Spezial, ohne Feder für grossen Türaufschlag bei dicken Korpusseiten

Anschlag	Oberfläche	Topf	CLIP TOP	Werks-Nr.	BLUMOTION	Werks-Nr.
Eckband	vernickelt	INSERTA	48.910.33	72T3590.TL	-	-

Montageplatten siehe Seite 43



O-Einsprung-/45° Gehrungs-Topfbänder BLUM CLIP Top BLUMOTION/CLIP TOP, 155°, mit Feder

Anschlag	Oberfläche	Topf	CLIP TOP	Werks-Nr.	BLUMOTION	Werks-Nr.
Eckband	vernickelt	INSERTA	48.909.10	71T7590	48.909.01	71B7590
Eckband	ONYX schwarz	INSERTA	-	-	48.909.02	71B7590
Eckband	vernickelt	Anschrauben	48.909.12	71T7550	48.909.05	71B7550
Eckband	ONYX schwarz	Anschrauben	-	-	48.909.06	71B7550
Eckband	vernickelt	Einpressen	-	-	48.909.08	71B7580
Eckband	ONYX schwarz	Einpressen	-	-	48.909.09	71B7580
Mittelband	vernickelt	INSERTA	-	-	48.909.03	71B7690
Mittelband	ONYX schwarz	INSERTA	-	-	48.909.04	71B7690
Mittelband	vernickelt	Anschrauben	48.909.13	71T7650	-	-
Mittelband	ONYX schwarz	Anschrauben	-	-	48.909.07	71B7650

TIP-ON

by Blum

TIP-ON siehe Seite 43

O-Einsprung-/45° Gehrungs-Topfbänder BLUM CLIP top, 155°, ohne Feder

Anschlag	Oberfläche	Topf	CLIP TOP	Werks-Nr.	BLUMOTION	Werks-Nr.
Eckband	vernickelt	INSERTA	48.909.14	70T7590.TL	-	-
Eckband	ONYX schwarz	INSERTA	48.909.15	70T7590.TL	-	-
Eckband	vernickelt	Anschrauben	48.909.16	70T7550.TL	-	-
Eckband	ONYX schwarz	Anschrauben	48.909.17	70T7550.TL	-	-
Mittelband	vernickelt	INSERTA	48.909.11	70T7690.TL	-	-
Mittelband	ONYX schwarz	Anschrauben	48.909.18	70T7650.TL	-	-



Weitwinkelband BLUM CLIP top/CLIP top BLUMOTION, 170°, mit Feder

Anschlag	Oberfläche	Topf	CLIP TOP	Werks-Nr.	BLUMOTION	Werks-Nr.
Eckband	vernickelt	INSERTA	48.910.90	71T6540B	48.910.97	973A6000
Eckband	vernickelt	Anschrauben	48.910.91	71T6550	-	-
Mittelband	vernickelt	INSERTA	48.910.93	71T6640B	-	-
Mittelband	vernickelt	Anschrauben	48.910.94	71T6650	-	-

TIP-ON

by Blum

TIP-ON siehe Seite 43

Weitwinkelband BLUM CLIP top, 170°, ohne Feder

Anschlag	Oberfläche	Topf	CLIP TOP	Werks-Nr.	BLUMOTION	Werks-Nr.
Eckband	vernickelt	Anschrauben	48.910.61	70T6550	-	-
Mittelband	vernickelt	INSERTA	48.910.62	70T6640B	-	-
Mittelband	vernickelt	Anschrauben	48.910.63	70T6650	-	-

Montageplatten siehe Seite 43

Auszug Scharnierprogramm CLIP TOP/CLIP TOP BLUMOTION



Profiltür-Topfbänder BLUM CLIP top BLUMOTION/CLIP top, 95 °, mit Feder

Anschlag	Oberfläche	Topf	CLIP TOP	Werks-Nr.	BLUMOTION	Werks-Nr.
Eckband	vernickelt	INSERTA	48.911.02	71T9590B	48.911.01	71B9590
Eckband	ONYX schwarz	INSERTA	-	-	48.913.21	71B9590
Eckband	vernickelt	Anschrauben	48.911.04	71T9550	-	-
Mittelband	vernickelt	INSERTA	48.911.11	71T9690B	48.911.10	71B9690
Mittelband	ONYX schwarz	INSERTA	-	-	48.913.23	71B9690
Mittelband	vernickelt	Anschrauben	-	-	48.911.12	71B9650
Mittelband	ONYX schwarz	Anschrauben	-	-	48.913.22	71B9650
Innenband	vernickelt	INSERTA	48.911.21	71T9790B	48.911.20	71B9790
Innenband	ONYX schwarz	INSERTA	-	-	48.913.25	71B9790
Innenband	vernickelt	Anschrauben	-	-	48.911.22	71B9750
Innenband	ONYX schwarz	Anschrauben	-	-	48.913.24	71B9750

TIP-ON

by Blum

TIP-ON siehe Seite 43

Profiltür-Topfbänder BLUM CLIP top, 95 °, ohne Feder

Anschlag	Oberfläche	Topf	CLIP TOP	Werks-Nr.	BLUMOTION	Werks-Nr.
Eckband	ONYX schwarz	INSERTA	48.913.09	70T9590BTL	-	-
Eckband	vernickelt	Anschrauben	48.911.05	70T9550.TL	-	-
Eckband	ONYX schwarz	Anschrauben	48.913.08	70T9550.TL	-	-
Mittelband	ONYX schwarz	INSERTA	48.913.11	70T9690BTL	-	-
Mittelband	vernickelt	Anschrauben	48.911.14	70T9650.TL	-	-
Mittelband	ONYX schwarz	Anschrauben	48.913.10	70T9650.TL	-	-
Innenband	ONYX schwarz	INSERTA	48.913.13	70T9790BTL	-	-



Spiegelbänder BLUM CLIP top BLUMOTION CRISTALLO, 110 °, mit Feder, Türauflage max. 19 mm

Anschlag	Oberfläche	Topf	CLIP TOP	Werks-Nr.	BLUMOTION	Werks-Nr.
Eck-Mittelband	vernickelt	zum Kleben	-	-	48.909.30	71B4500C
Eck-Mittelband	ONYX schwarz	zum Kleben	-	-	48.909.31	71B4500C
Eck-Mittelband	vernickelt	zum Kleben	48.909.32	71T4500C	-	-
Topfplatte	vernickelt	zum Kleben	-	-	48.909.35	70T4568C
Topfplatte	sonder vernickelt	zum Kleben	-	-	48.909.36	70T4568C
Montageplatte	Glasvitrinen	zum Kleben	-	-	48.909.37	175M4C20

Montageplatten siehe Seite 43

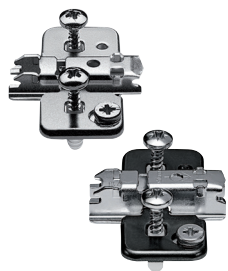

Excenter-Kreuzmontageplatten BLUM CLIP, EXPANDO

Oberfläche	Distanz	Eckanschlag	Werks-Nr.	Mittelanschlag	Werks-Nr.
vernickelt	0 mm	48.916.21	174H7100E	48.916.31	174H710ZE
ONYX schwarz	0 mm	48.913.50	174H7100E	-	-
vernickelt	3 mm	48.916.22	174H7130E	48.916.32	174H713ZE
ONYX schwarz	3 mm	48.913.51	174H7130E	-	-



Excenter-Kreuzmontageplatten BLUM CLIP

Oberfläche	Distanz	Spanplatten-Schrauben	Werks-Nr.	INSERTA	Werks-Nr.
vernickelt	0 mm	48.916.01	173H7100	48.916.11	174H7100I
vernickelt	3 mm	48.916.02	173H7130	48.916.12	174H7130I



Excenter-Kreuzmontageplatten BLUM CLIP

Oberfläche	Distanz	Spanplatten-Schrauben	Werks-Nr.	System-Schrauben	Werks-Nr.
vernickelt	0 mm	48.916.41	175H7100	48.916.51	175H9100
vernickelt	3 mm	48.916.42	175H7130	48.916.52	175H9130
vernickelt	6 mm	-	-	48.916.53	175H9160
ONYX schwarz	6 mm	-	-	48.913.54	175H9160
vernickelt	9 mm	48.916.43	175H7190	48.916.54	175H9190
vernickelt	18 mm	-	-	48.916.55	175H9190.22

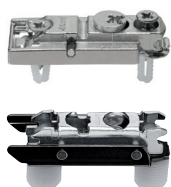

Linearmontageplatten BLUM CLIP Eckmontage mit Excenter-Höhenverstellung

Oberfläche	Distanz	EXPANDO	Werks-Nr.	Einpressen	Werks-Nr.
vernickelt	0 mm	48.915.11	177H3100E	48.915.41	177H3100
ONYX schwarz	0 mm	-	-	48.913.55	177H3100
vernickelt	3 mm	48.915.12	177H3130E	48.915.42	177H3130
ONYX schwarz	3 mm	-	-	48.913.56	177H3130

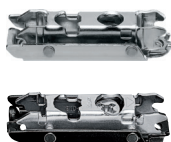

Linearmontageplatten BLUM CLIP Eckmontage mit Excenter-Höhenverstellung

Oberfläche	Distanz	Spanplatten-Schrauben	Werks-Nr.	Einpressen	Werks-Nr.
vernickelt	0 mm	48.915.01	175H3100	48.915.71	177H5100
ONYX schwarz	0 mm	48.913.52	175H3100	-	-
vernickelt	3 mm	48.915.02	175H3130	48.915.72	177H5130
ONYX schwarz	3 mm	48.913.53	175H3130	-	-

TIP ON für Türen



TIP-ON 956	seidenweiss	platingrau	terraschwarz	nickel-lack.	Werks-Nr.
TIP-ON kurz mit Magnet	48.918.02	48.918.01	48.918.03	-	956.1004
Adapterplatte kurz	48.918.31	48.918.30	48.918.32	48.918.33	956.1201
TIP-ON lang mit Puffer	48.918.22	48.918.21	48.918.23	-	956A1006
TIP-ON lang mit Magnet	48.918.12	48.918.11	48.918.13	-	956A1004
Adapterplatte lang	48.918.36	48.918.35	48.918.37	48.918.38	956A1201
Kreuzadapterplatte lang	-	48.918.40	-	-	956A1501

Frontbefestigung für Schubkastenzargen BLUM TANDEMBOX antaro



Lieferumfang:

- MP = Multipack 1 Stück (2 Stück pro Schubkasten erforderlich)
- IP = Industriepack Packung 500 (EXPANDO) oder 200 (zum Anschrauben)

Korpusbreite	Zargenhöhe	Packung	Montage		Montage	
			EXPANDO	Werks-Nr.	zum Anschrauben	Werks-Nr.
275 -1200 mm	N/M/K	MP	53.800.12	ZSF.39A2	53.800.03	ZSF.35A2
275 -1200 mm	N/M/K	IP	53.800.01	ZSF.39A2	53.800.10	ZSF.35A2

Fronthalter für Vorderstück TANDEMBOX antaro für Innenschubkasten



Lieferumfang:

- 1x Fronthalter links/rechts
- 1x Halteteil



Korpusbreite	Zargenhöhe	Systemhöhe	Typ	seidenweiss	grau RAL 9006	terraschwarz	Werks-Nr.
275 -1200 mm	M	M	Fronthalter	53.801.60	53.811.60	53.821.60	ZIF.71MO
276 -1200 mm	K	K	Fronthalter	53.801.95	53.811.95	53.821.95	ZIF.71KO

Fronthalter für Vorderstück mit Querreling BLUM TANDEMBOX antaro für Frontinnenschubkasten



Lieferumfang:

- 1x Fronthalter links/rechts
- 1x Halteteil
- 2x Relingkopf

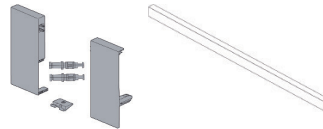

Korpusbreite	Zargenhöhe	Systemhöhe	Typ	seidenweiss	grau RAL 9006	terraschwarz	Werks-Nr.
275 -1200 mm	M	C	Fronthalter	53.802.71	53.812.71	53.822.71	ZIF.74CO
275 -1200 mm	M/K	D	Fronthalter	53.803.40	53.813.40	53.823.40	ZIF.74DO
275 -1200 mm	M/K	C/D	Querreling*	53.802.72	53.812.72	53.822.72	ZRG.1046Z
275 -1200 mm	M/K	C/D	Relingkopf (Ersatzteil)	53.822.19	53.822.19	53.822.19	ZRG.000R5F
275 -1200 mm	M/K	C/D	Halteteil (Ersatzteil)	53.801.99	53.801.99	53.801.99	Z31A0008

* Zuschnitt: LB -122 mm

Vorderstück ohne Nut in Fixbreiten oder zum Ablängen für Innenschubkasten/Frontinnenschubkasten

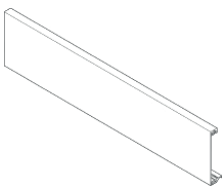

Korpusbreite	Zargenhöhe	Systemhöhe	Korpusseitenstärke	seidenweiss	grau RAL 9006	terraschwarz	Werks-Nr.
275 mm	M/K	M/K/C/D	16 mm	53.801.62	-	-	Z31L111A
300 mm	M/K	M/K/C/D	16 mm	53.801.63	-	-	Z31L136A
400 mm	M/K	M/K/C/D	16 mm	53.801.64	-	-	Z31L236A
450 mm	M/K	M/K/C/D	16 mm	53.801.65	-	-	Z31L286A
500 mm	M/K	M/K/C/D	16 mm	53.801.66	-	-	Z31L336A
550 mm	M/K	M/K/C/D	16 mm	53.801.67	-	-	Z31L386A
600 mm	M/K	M/K/C/D	16 mm	53.801.68	-	-	Z31L436A
275 -1200 mm	M/K	M/K/C/D	16/19 mm*	53.801.61	53.811.61	53.821.61	Z31L4136A

* Zuschnitt: LW -132 mm

Griff für Innenschubkasten BLUM TANDEMBOX antaro



Korpusbreite	Zargenhöhe	Systemhöhe	Typ	seidenweiss	grau RAL 9006	terraschwarz	Werks-Nr.
275 -1200 mm	M/K	M/K/C/D	Griff ohne Mitnehmer	53.801.70	53.811.70	53.821.70	ZSF.35A2
275 -1200 mm	M/K	M/K/C/D	Griff mit Mitnehmer	53.801.71	53.811.71	53.821.71	

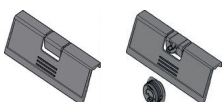

Nutzen/Vorteile und Serviceleistungen auf den Punkt gebracht

BLUM QuickFinder mit Eindruck von OPO-Nr./Werks-Nr./Packungseinheiten



Lieferumfang:
BLUMOTION S links/rechts

	MP = Multipack L/R - Packung 1/6	IP = Industriepack L/R - Packung 12	Werks-Nr.
Nennlänge	40 kg MP	40 kg IP	
500 mm	53.891.08	53.894.06	750.5001S
550 mm	53.891.11	53.894.07	750.5501S

Ihr Nutzen

- Direkter Vergleich OPO-Nr./Werks-Nr.
- Übersichtliche Darstellung von Industrie- und Multipackungen

Ihr Vorteil

- Bestellsicherheit/Nummerntransparenz zu BLUM Arbeitshandbuch
- Kostenersparnis durch bestelloptimierten Einkauf von Industrie- und Multipackungen

Komfortable, schnelle Bestellung dank bestellfertig vorerfassten Kompett-Schubkasten-Sets

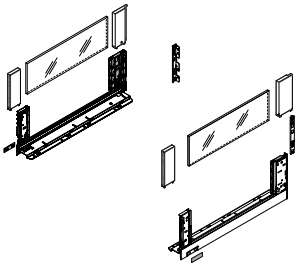

- Einfacher Bestellprozess durch erfassen aller Schubkastenkomponenten mit nur einer OPO-Nr.
- Komplett zusammengestelltes Set für Schubkasten mit Holzrückwand

- Eliminierung von Erfassungsfehlern - alle notwendigen Komponenten pro Schubkasten sind enthalten
- schnelle Bestellerfassung, einfache und leicht verständliche Handhabung

Direktdownload von vielen BLUM CAD Zeichnungen direkt ab OPO-Net®

Vorschau **2D** 3D Spezialformate

Hier finden Sie Vorschaubilder sowohl in 2D (Ansicht, Grund- und Seitenriss), als auch in 3D (Volumen und Volumenschnitt).

Komp- lett	Komp- lett	Ansicht	Grund- riss	Seiten- riss	Vol 3D	Vol 3D	Vol 3D Schnitt	Vol 3D Schnitt
<input type="checkbox"/>	<input type="checkbox"/>	<input type="checkbox"/>	<input type="checkbox"/>	<input type="checkbox"/>	<input type="checkbox"/>	<input type="checkbox"/>	<input type="checkbox"/>	<input type="checkbox"/>
+ alle	+ alle	+ alle	+ alle	+ alle	+ alle	+ alle	+ alle	+ alle

+ alle auswählen
+ alle abwählen

Download

MIT EINEM KLICK ZU CAD-FORMATEN

Über 1600 BLUM-Artikel auf dem OPO-Net® verfügen über CAD/CAM Daten. Unter «Ergänzende Informationen» können Sie im OPO-Net® direkt beim Produkt aus einer Vielzahl von unterschiedlichen 2D und 3D-Formaten wählen und Ihre Auswahl bequem herunterladen. Damit hilft OPO Oeschger Ihnen, die Planung und Fertigung mit dem BLUM-Sortiment noch besser und einfacher zu handhaben.

Direkter Stücklistenimport in OPO-Net® Warenkorb ab BLUM Produktkonfigurator

Bestellung uploaden

Sie können hier Dateien bestimmter unterstützter Formate von Ihrem PC hochladen und Artikel direkt per Upload in den Warenkorb laden. Bitte beachten Sie die Vorgaben der unterstützten Formate und wählen Sie den entsprechenden Dateityp aus.

Bestelldatei wählen
Datei auswählen Keine ausgewählt

Dateiformat wählen
Blum Excel- oder CSV-Format

wenn keine Kommission angeben an folgender zuweisen
ohne Kommission

UPLOAD STARTEN ABRUCH

STÜCKLISTENIMPORT DIREKT IN DEN OPO-NET® WARENKORB

Sie arbeiten mit dem BLUM Online-Produktkonfigurator, um für Ihre individuellen Planungen die passenden Beschläge zu ermitteln? Mit der neuen Direktimport-Schnittstelle von OPO Oeschger können Sie nun die mit dem BLUM Online-Konfigurator generierten Stücklisten direkt und bequem in den OPO-Net® Warenkorb importieren. Einfach Stücklisten herunterladen und importieren – fertig!

Höchste Liefertreue und Sicherheit durch hohe Logistikqualität



Profitieren Sie von unserem exzellenten Lieferservice und unseren massgeschneiderten Dienstleistungspaketen wie eBill, Bestellungen bis 18.00 Uhr, Post Express Gleichtags oder Nachtbelieferung "Innight" um nur einige davon zu nennen. Ihr zuständiger Berater im Aussendienst hilft Ihnen gerne das passende Servicepaket zugeschnitten auf Ihren Betrieb zu schnüren.

Klappenbeschläge AVENTOS

Scharniersysteme CLIP top BLUMOTION

Hauptsitz:**OPO Oeschger AG****Steinackerstrasse 68
8302 Kloten****T +41 44 804 33 11****F +41 44 804 33 99** **opo@opo.ch****Schreiner und Innenausbau**

Kloten	Steinackerstrasse 68 8302 Kloten	T 044 804 33 22	F 0848 802 077	kloten@opo.ch
Köniz	Gartenstadtstrasse 8 3098 Köniz	T 031 978 62 62	F 0848 802 077	koeniz@opo.ch
St. Gallen	Simonstrasse 7 9016 St. Gallen	T 071 282 41 51	F 0848 802 077	st.gallen@opo.ch
Pratteln	Bahnhofplatz 1 4133 Pratteln	T 061 756 05 50	F 0848 802 077	pratteln@opo.ch
Kriens	Grabenhofstrasse 6 6010 Kriens	T 041 349 10 70	F 0848 802 077	kriens@opo.ch
Crissier	Ch. de Longemarlaz 6 1023 Crissier	T 021 632 82 32	F 0848 802 077	crissier@opo.ch
Manno	Via Cantonale 2a 6928 Manno	T 091 611 90 11	F 0848 802 077	manno@opo.ch
Küchen- und Wohnmöbelindustrie	Steinackerstrasse 68 8302 Kloten	T 044 804 33 44	F 044 804 33 72	industrie@opo.ch
Glas- und Metallbau	Steinackerstrasse 68 8302 Kloten	T 044 804 31 99	F 044 804 31 97	glasmetallbau@opo.ch
	Westschweiz	T 021 632 84 77	F 021 632 84 78	verremetal@opo.ch
Wiederverkauf	Steinackerstrasse 68 8302 Kloten	T 044 804 32 60	F 044 804 32 64	wiederverkauf@opo.ch
Werkraumeinrichtungen	Steinackerstrasse 68 8302 Kloten	T 044 804 33 55	F 044 804 33 57	schulen@opo.ch

